



REF 19949421

TOTALSOURCE®

KEY SWITCHES





TVH PARTS NV • PARTS & ACCESSORIES DIVISION
Brabantstraat 15 • BE-8790 Waregem
T +32 56 43 42 11 • F +32 56 43 44 88 • parts@tvh.com • www.tvh.com





KEY SWITCHES

For all our latest catalogue updates and company info: www.tvh.com

 Most articles stated in this catalogue are available from stock, unless they were sold out after the publication of this catalogue. Contact us if you require a similar article that is not shown in this catalogue: alternatives might be available. TVH is a supplier of spare parts and accessories suitable for OEM-equipment. OEM-references and makes are purely indicative and do not imply that the accessories and/or spare parts originate from the original equipment or parts manufacturer. Please consult our general terms and conditions of sale on www.tvh.com/avv.

 De meeste in deze catalogus vermelde artikelen zijn uit voorraad leverbaar, tenzij ze na publicatie van deze catalogus uitverkocht werden. Contacteer ons indien u een gelijkaardig artikel wenst dat niet in deze catalogus is opgenomen: het is mogelijk dat wij ook dit kunnen leveren. TVH is een leverancier van reserveonderdelen en accessoires geschikt voor OEM-uitrusting. OEM-referenties en merken zijn enkel indicatief en betekenen niet dat de accessoires en/of onderdelen afkomstig zijn van de originele toestel- of onderdelenfabrikant. Gelieve onze algemene verkoopsvoorwaarden te consulteren op www.tvh.com/avv.

 La plupart des articles mentionnés dans ce catalogue sont disponibles sauf si épuisement du stock à la publication de ce catalogue. Contactez-nous si vous souhaitez un article similaire qui n'est pas repris dans ce catalogue : il est possible que nous pouvons vous le fournir. TVH est un fournisseur de pièces détachées et d'accessoires adaptables sur des marques constructeurs. Les références et marques constructeurs sont uniquement indicatives et n'impliquent pas que les accessoires et/ou pièces proviennent du fabricant de la machine ou de la pièce d'origine. Veuillez consulter nos conditions générales de vente sur www.tvh.com/avv.

 Die meisten Artikel die in diesem Katalog aufgeführt sind, sind ab Lager lieferbar, es sei denn, das die Artikel durch die Veröffentlichung von diesem Katalog ausverkauft sind. Kontaktieren Sie uns, wenn Sie Interesse haben in ein ähnliches Artikel, das nicht im Katalog aufgeführt ist: es ist möglich das wir es liefern können. TVH ist ein Lieferant von Ersatzteilen und Zubehör geeignet für OEM-Ausstattung. OEM-Referenzen gelten nur als Indiz, und implizieren nicht, dass das Ersatzteil vom Originalhersteller des Geräts oder Ersatzteil kommt. Konsultieren Sie unsere Allgemeinen Geschäftsbedingungen auf www.tvh.com/avv.

 La mayoría de los artículos que figuran en este catálogo se encuentran en stock, a menos que tras la publicación de este catálogo se hayan agotado. Contacte con nosotros si desea un artículo similar que no se halle en este catálogo : es posible que podamos ofrecerle aquel que usted necesita. TVH es un proveedor de recambios y accesorios adecuados para equipos OEM. Las referencias y marcas OEM mencionadas son meramente indicativas y no implican que los accesorios y / o recambios procedan del fabricante de maquinaria o recambios original. Por favor, consulte nuestras condiciones de venta en www.tvh.com/avv.

 La maggior parte dei ricambi elencati in questo catalogo sono a stock, a meno che dopo la pubblicazione di questo catalogo sono stati venduti. Contattaci se desiderate un articolo simile che non è riportato in questo catalogo: è possibile che possiamo offrire anche questi. TVH è un fornitore di pezzi di ricambio e accessori per OEM, riferimenti OEM e marche sono solo indicativi e non implicano che gli accessori e/o di componenti derivino dal costruttore originale o dal produttore del componente. Si prega di consultare i nostri termini di vendita su www.tvh.com/avv.

 Części z tego katalogu są zazwyczaj na stanie magazynowym. Również części które nie są wyszczególnione w katalogu mogą być dostarczone na zamówienie w najkrótszym możliwym terminie. Opis części O.E.M. jest używany informacyjnie i nie wskazuje na to, że dany produkt jest wyprodukowany przez podanego producenta. Zawartość katalogu może ulec zmianie bez wcześniejszego informowania o tym. Wszystkie użyte zdjęcia, rysunki, nazwy marek, opis i numery służą tylko do identyfikacji.

 Запчасти из настоящего списка, как правило, имеются в запасе, если только он не распродан. Прочие, не фигурирующие в списке артикулы, могут быть поставлены в самые кратчайшие сроки. Указание оригинальных номеров производителя не предполагает обязательного оригинального происхождения самих деталей. Данный список может изменяться без предварительного уведомления. Все использованные фото, рисунки, иллюстрации, названия брендов, наименования и номера служат исключительно для цели идентификации.

© May 2013 TVH Group NV, Brabantstraat 15, BE-8790 Waregem.

TVH®, TotalSource®, TotalLifter®, Climax®, Cam system® are registered trademarks. All rights reserved. No part of this publication may be reproduced or communicated in any form or by any means, electronic or mechanical, including copying, recording or use in an information storage or retrieval system, without prior and explicit permission of TVH Group NV. TVH is a supplier of after-market spare parts and accessories that are fitted for maintenance and repair of OEM-equipment. OEM references and brands are purely indicative and do not imply that the accessories and/or spare parts are coming from the original equipment or parts manufacturer. Printing errors reserved. Photographs and illustrations are included for reference purposes only. This information is stored in the TVH customer database for the duration of the customer-supplier relationship, in accordance with the applicable privacy legislation. You can request the TVH customer service in writing for access to and correction of your details. Your information will not be transmitted to third parties. All sales are subject to the general terms & conditions of sale on www.tvh.com/avv.



Dear customer,

More than 40 years ago, in 1969, the success story of TVH began. Mr Paul Vanhalst and Mr Paul Thermote, neighbours and school friends, joined their forces and started with the purchase and repair of agricultural machines and used lift trucks.

Increasing industrialisation led to a growing need for lift trucks and lift truck parts. Slowly but surely, TVH was growing into a global player, thanks to the success of the product and customer service, but also thanks to acquisitions. TVH turned into an all-round supplier, a real one-stop shop, by adding hand pallet trucks, hand trolleys, lifting cranes ... to its range and by setting up a domestic rental division.

TVH Group is organized in 2 important activities: Parts & Accessories and Rental & Equipment. This last activity has 3 divisions, namely Equipment Division (sales of second-hand lift trucks and aerial work platforms), Rental Division (short- and long-term renting of lift trucks and aerial work platforms) and Service & Repair Division. The Rental Division is active in Belgium, the Netherlands, Luxemburg, Czech Republic, Germany, Poland, Slovakia, Hungary, Romania and Serbia. The Service & Repair Division is a service we only offer in Belgium.

After all these years, the business is still in family hands and has grown from 2 founders, to a workforce of almost 4000 employees worldwide, in 5 continents. The day-to-day management has now been handed over to the second generation.

The Thermote & Vanhalst families



PARTS & ACCESSORIES





TVH Worldwide

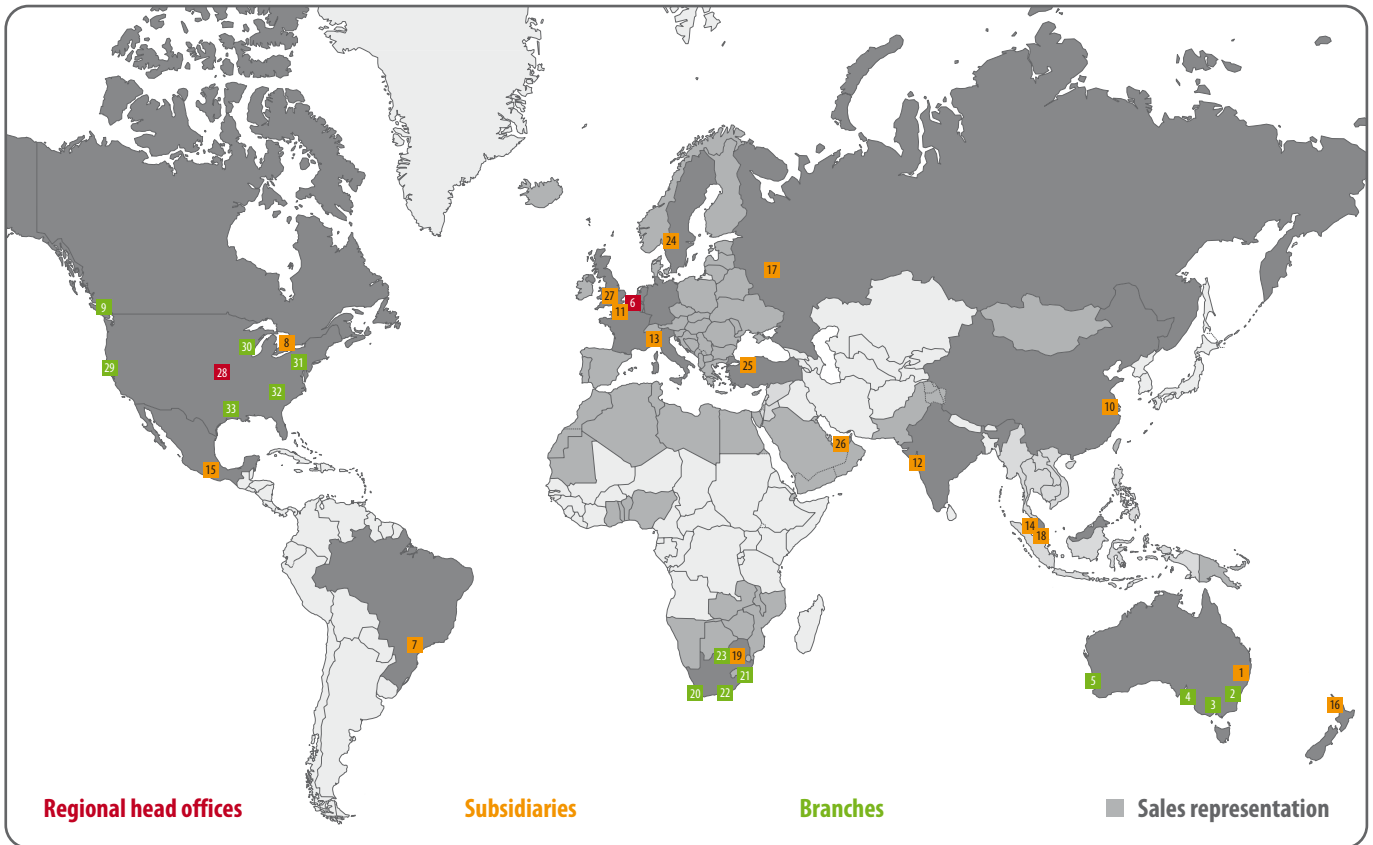

AUSTRALIA

- 01 TVH AUSTRALASIA PTY LTD (Queensland)
Richlands (Brisbane)
- 02 TVH AUSTRALASIA PTY LTD (New South Wales)
Wetherill Park (Sydney)
- 03 TVH AUSTRALASIA PTY LTD (Victoria)
Dandenong South (Melbourne)
- 04 TVH AUSTRALASIA PTY LTD (South Australia)
Wingfield (Adelaide)
- 05 TVH AUSTRALASIA PTY LTD (West Australia)
Welshpool (Perth)



BELGIUM

- 06 THERMOT & VANHALST NV
Waregem
- 06 CC HEFTRUCKS BVBA
Nieuwerkerken (Aalst)
- 06 HAVELANGE SA
Vilvoorde (Brussel)
- 06 TVH RENTAL EQUIPMENT NV
Waregem
- 06 TVH PARTS NV
Waregem



BRASIL

- 07 TVH DINAMICA PEÇAS LTDA
Vinhedo (São Paulo)



CANADA

- 08 TVH CANADA LTD (Ontario)
Mississauga (Toronto)
- 09 TVH CANADA LTD (British Columbia)
Port Coquitlam (Vancouver)



CHINA

- 10 TVH TRADING (SHANGHAI) CO, LTD
Shanghai



FRANCE

- 11 TVH FRANCE SASU
Roubaix



INDIA

- 12 TVH INDIA PTE LTD
Pune



ITALY

- 13 TVH ITALIA SRL
Marano Ticino (Novara), Torino
- 13 CAM SRL
Marano Ticino (Novara)



MALAYSIA

- 14 TVH MALAYSIA SDN BHD
Shah Alam (Kuala Lumpur)



MEXICO

- 15 TVH MEXICO, S DE RL DE CV
Cuauhtitlán Izcalli (Mexico City)



NEW ZEALAND

- 16 TVH NEW ZEALAND LTD
East Tamaki (Auckland)



RUSSIA

- 17 TVH RUS LLC
Dubrovki (Moscow)



SINGAPORE

- 18 TVH SINGAPORE PTE LTD
Jurong



SOUTH AFRICA

- 19 TVH PARTS SOUTH AFRICA LTD
Isando (Johannesburg)
- 20 TVH PARTS SOUTH AFRICA LTD
Kraaifontein (Cape Town)
- 21 TVH PARTS SOUTH AFRICA LTD
Briardene (Durban)
- 22 TVH PARTS SOUTH AFRICA LTD
Karsten (Port Elisabeth)
- 23 TVH PARTS SOUTH AFRICA LTD
Lichtenburg



SWEDEN

- 24 TVH NORDIC AB
Ed



TURKEY

- 25 TVH YEDEK PARÇA TICARET AŞ
Başakşehir (Istanbul)



UNITED ARAB EMIRATES

- 26 TVH MIDDLE EAST FZE
Sharjah



UNITED KINGDOM

- 27 TVH UK LTD
Coventry



USA

- 28 TVH PARTS CO (Kansas)
Olathe
- 29 TVH PARTS CO (California)
Mira Loma
- 30 TVH PARTS CO (Illinois)
Grayslake
- 31 TVH PARTS CO (Pennsylvania)
Harrisburg
- 32 TVH PARTS CO (South Carolina)
Duncan
- 33 TVH PARTS CO (Louisiana)
Shreveport
- 28 SUPERIOR SIGNALS, INC (Kansas)
Olathe

SALES REPRESENTATION IN THE FOLLOWING COUNTRIES:

Albania, Algeria, Austria, Bahrain, Belarus, Benin, Bosnia, Botswana, Bulgaria, Canary Islands, Croatia, Cyprus, Czech Republic, Denmark, Djibouti, Egypt, Estonia, Finland, Germany, Ghana, Greece, Hong Kong, Hungary, Iceland, Ireland, Kosovo, Kuwait, Latvia, Libya, Lithuania, Luxembourg, Macedonia, Malta, Morocco, Mozambique, Mauritania, Moldova Republic, Montenegro, Namibia, Netherlands, Nigeria, Norway, Oman, Pakistan, Poland, Portugal, Qatar, Romania, Saudi Arabia, Serbia, Slovakia, Slovenia, Spain, Switzerland, Taiwan, Togo, Tunisia, Ukraine, Yemen, Zambia, Zimbabwe.



TVH@social media



Like us on Facebook

Social media are the way to communicate. TVH felt the same about this and opened a Facebook account. We inform you about our new products, other product innovations, events and trade fair participations.

www.facebook.com/tvhgroup

Follow us on Twitter and LinkedIn

Facebook users usually also have two other social media accounts: Twitter and LinkedIn. Follow us here for the latest news and recent vacancies.

www.twitter.com/tvhgroup
www.linkedin.com/companies/tvh

Our social media accounts are updated frequently. Feel free to post reactions, photos and any other interesting news.

TVH@TV: Watch us!



We want to keep you as well-informed as we possibly can. Therefore, we have been making movies about our products and services that could use some extra explanation. This way you have an even better overview of what we can offer you.

You can find all our videos on www.tvh.tv. We have divided the movies into categories to keep a clear overview for you.

- The category **About TVH** provides you with our company movie in 8 languages: Dutch, French, English, German, Spanish, Portuguese, Italian and Polish. This is a way to get to know TVH: what does our company look like, which products can we supply you with, who is your contact person ...

- **Product movies:** promotional clips and visual manuals can be found in the category **Our product range**.
- **E-commerce tools** contains a number of demo videos on how to work with search engines such as MyProductSearch and MyPartsFinder.
- Via **New catalogues** we inform you on how you can easily look up parts in our Master catalogue.

TVH also has its own Training Centre. Via **Training@TVH** you can see what our trainings can mean for you.



FOLLOW US





Abeko • Aichi • Allis Chalmers-Kalmar AC • Armani • Artison • Asea • Atlet • Audureau • Ausa • Baka • Balkancar • Baoli • Battioni e Pagani • Baumann • Belet • Bobcat • Bolzoni • Bonser • Boss • Brunilift • BT • Bulli Kahl • BV Vestergaard • Cangaru • Carer • Carreffe • Caterpillar • Cesab • Charlatte • Clark • Climax • Comac • Conveancer • Coventry Climax • Crown • CTC • CVS Ferrari • Dalian • Dambach • Dantruck • Datsun • Deca • Desta • Dhollandia • Dieci • Dinolift • Dulevo • Ecolift • Eurolifter • EP • Faba • Fantuzzi • Fenwick • Genie • Genkinger • Grove • Hako • Halla • Hallins • Hangcha (HC) • Harlan • Haulotte • Heden-Dantruck • Heli • Henley • Hyster • Hyundai • Icem • Incab • Indos • Italmacchine • JCB • JLG • Jumbo • Jungheinrich • Kalmar • Kärcher • Kentruck-Robur • Kinglifter Terberg • Komatsu • Kooi Aap • Lafis • Lancer Boss • Lansing • LGM • Lifter • Linde • Loc • Logitrans • Lugli • Magliner • Manitou • MBB • Merlo • Miag • MIC • Minuteman • Mitsubishi • Moffett • Montini • Mora • Nichiyu-Nyk • Niftylift • Nilfisk-Advance • Nissan • Noblelift • Nuova Detas • O & K • OM • OMG • Patria • Peg-Fenwick • Pimespo • Powerboss • Pramac • Prat • Ranger • RCM • Rocla • Salev • Samag • Sambron • Samsung • Sanderson • Saxby • Sichel Schmidt • Sisu • Skyjack • SMV Konecranes • Snorkel • Steinbock • Still • Stocka • Stocklin • Svetruck • Tailift • TCM • Tecnocar • Tennant • Terex • TotalLifter • Toyota • Unitrac • Upright • Valmet • Wagner • Whiptruck • Yale • Yang-Yam-Puma

500 000

stock items

20 000 000

known references

TOTALSOURCE

TOTALLIFTER

Climax

cam
system
LIFT TRUCK ATTACHMENTS

PG DRIVES TECHNOLOGY
POWER TRANSMISSIONS FOR LIFT TRUCKS

Beta
authorised factory distributor

FLUKE
Official Fluke distributor

Authorized Service
and Repair Centre for
Europe
CURTIS

PRESSOL

TECH OPS
SEVCON

ZECA



Accessories & handling equipment catalogue



REF 16865558

The Accessories & handling equipment catalogue shows you what TVH can offer you in the following ranges:

- Hand pallet trucks
- Scissor hand pallet trucks
- Warehouse equipment
- Trolleys & rollers
- Mechanical & hydraulic attachments
- Lift tables, stackers ...

Parts magazine



REF 18811116

In this half-yearly magazine on parts, we show you our new products, interesting information on specific products and interviews with some of our product responsables and other colleagues.

Industrial equipment parts & accessories



REF 19550200

TVH has become more than a supplier for forklift parts. This magazine gives you an overview of what products or parts we can offer you, besides our forklift parts.

Product specials

We gladly keep you informed of our extensive product range. In addition to our parts catalogues we therefore also present you with our 'product specials': useful digital brochures that will guide you within specific product categories. Save the link in your favourites. You will regularly discover new e-folders with numerous innovations.



Beta quality tools & workwear

REF 17857457

Brake fluids, mineral & transmission oils

REF 14286693

Document & accessories holders

REF 14372877

Drum handling special

REF 18253535

Forks & accessories

REF 14616237

Hardware special

REF 18805081

Jacks & supports special

REF 18178749

Light special

REF 15765795

Maintenance special

REF 18380005

Mirror special

REF 16611497

Press special

REF 17868205

Pressol, lubrication & garage equipment

REF 17783573

Safety & ergonomics

REF 18666614

Seat special

REF 14836726

Skips, scoops & crane jibs

REF 18795192

Twistlocks

REF 19550195

Tyres & accessories

REF 15372984

Weighing special

REF 18329658

Windows special

REF 18545076

Winter products

REF 18663385



Watch our company movie



TVH catalogues

Your source of information

TVH has a wide range of catalogues. Each catalogue gives you information about one or more specific product groups or two related product groups from our range. The extensive and detailed information contains: pictures, dimensions, general product info ... The books of interest can be ordered for free by using the given reference numbers.

One free copy per customer. Additional copies for sale. Five euro will be charged as of the first copy of our 3 largest parts catalogues, Hydraulics, Starters & alternators and Exhaust systems.

Batteries, chargers & accessories

REF [15262190*](#)

Batteries & accessories, battery maintenance, traction battery chargers, HF traction battery chargers and connectors. Also with useful tips and extra info about the functioning and maintenance of batteries.



Brushes

REF [7901151*](#)

Brushes & brush kits, technical sheets and general brush information.

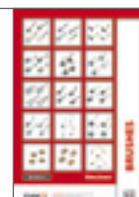

Bulbs

REF [9103419](#)

This catalogue is also available on Infogate and online in French, German and Spanish. An overview of all types of bulbs, grouped by the fitting types.



Chains & accessories

REF [15282597*](#)

Leaf chains, roller chains, chain anchors, accessories such as chain wear gauges, chain spray, chain cutters, riveting tools ...



Consumables & accessories

REF [19524706*](#)

Personal equipment and safety, industrial vehicle repair, maintenance parts and accessories, workshop consumables and accessories, warehouse accessories, on the field.



Contactors & contacts

REF [10185471*](#)

An overview of contactors, contacts and contact kits (grouped by brand), technical sheets of the contactor contact and the contactor contact kit.



Engine parts

REF [8255616*](#)

Based on engine make, all parts can be looked up.



Exhaust systems

REF [10727802*](#)

An overview of all references for mufflers, exhaust tubes, exhaust purifiers, exhaust accessories and tools & measuring instruments.



Fuses & fuse holders

REF [9103420*](#)

Fuse strips, fuse plugs for automotive use, stud-mounted fuses, knife-type fuses, screw-type fuses, plug-in fuses, sub-miniature fuses, special fuses, automatic fuses and fuse holders.



Hand pallet truck parts

REF [10550844*](#)

An overview of all hand pallet truck parts, based on hand pallet truck make.



Hydraulic system parts

REF [14702080*](#)

This catalogue is only available on Infogate and online: Hydraulic pumps, orbitrols, hydraulic motors, hydraulic cylinders, distributor blocks, auxiliary valves & handle kits, transmission valves, electrovalves ...



Key switches

REF [19949421*](#)

An overview of all key switches by make, a complete range of keys and the electronic code switch.



Labels & decals

REF [12594102*](#)

An overview of all available labels & decals in the following categories: kit, dashboard, fork, liquid, safety, tyres, capacity and miscellaneous.



LPG system parts

REF [12410757*](#)

Universal kit LPG, Aisan-Nikki, Algas, Beam, Century, Impco, LPG-kit with Impco carburetor & regulator, J & S, Landi Hartog, Lovato, Renzo Landi, Zenith-Bendix, filter, choke, LPG fuel tanks, governors.



* only available in English



<p>Mast rollers (profiles & accessories) REF 7872482* An overview of all mast rollers per type and some accessories: mast profiles, fork carriage profiles, shims, carriages, shaft roller upright.</p>	<p>Paint & accessories REF 7882672* An overview of all paint (in pots or spray) by make, and the accessories for painting (thinner, spraymaster, masking foil, disposable overalls, emery paper, mini grinder/sander,...)</p>
<p>Potentiometers & encoders REF 7835233* An overview of all potentiometers and encoders per type, technical sheet for encoders & tachogenerators and potentiometers.</p>	<p>Relays REF 7083552* An overview of all relays, flasher units, solenoids & contactors for general use and accessories.</p>
<p>Replacement parts suitable for scrubbers & sweepers REF 18538625* This catalogue shows you all parts and accessories for sweepers and scrubbers for which you can contact TVH. It gives you an overview of the types of brushes and their material, batteries, seats, filters ...</p>	<p>Rubber tracks for mini-excavators and skid steer loaders REF 14089352 – English, REF 14547024 – Dutch REF 14343401 – French, REF 14331309 – German Rubber tracks and rubber pads for mini-excavators and skid steer loaders, ground support plates and stabilizer plates.</p>
<p>Seats & accessories REF 13991397* Seat pans, narrow seats, standard seats, universal seats, anti-static & heated seats, accessories and safety systems.</p>	<p>Starters & alternators REF 6252659* Starters, alternators, universal alternator, ring gears, flywheels, V-belts, technical sheets for: starter, starter armature, bendix drives, alternator, ring gears, flywheel.</p>
<p>Tail lift parts REF 14329675* Battery products, seals, electrical parts, hydraulic parts, filters, hardware, safety & service products.</p>	<p>Tyres, rims, rubber tracks & accessories REF 20064130* Super elastic tyres, premium super elastic tyres, pneumatic tyres, press-on tyres, rubber tracks, rubber pads, ground support plates, stabiliser plates, rims, tyre press, accessories, wheels, rollers & castors.</p>
<p>Wheel brake & master cylinders REF 7072186* An overview of brake & clutch cylinders per make, accessories and technical sheets.</p>	<p>Wheels, rollers & castors REF 6781097* For pallet trucks & handling equipment: rollers, load wheels, drive wheels, wheels with internal keyway, wheels with internal crown/gear, wheels with brake kit, castors. For handling equipment: roller assemblies. Used on wheels for manual and electric hand pallet trucks: bearings.</p>
<p>Beta tools & workwear This catalogue is available online on www.tvh.com/beta The complete Beta range of tools and workwear.</p>	<p>Fluke REF 14691770* Selection from the Fluke test tools range. All articles standard in stock.</p>
<p>Replacement parts suitable for Haulotte REF 15069637* Battery products, electrical parts, hydraulic parts, engines, filters, hardware, basket parts, safety & service products.</p>	<p>Replacement parts suitable for Genie REF 12726578* Battery products, electrical parts, hydraulic parts, engines, filters, hardware, basket parts, safety & service products.</p>
<p>Replacement parts suitable for JLG REF 12613028* Battery products, electrical parts, hydraulic parts, engines, filters, hardware, basket parts, safety & service products, scale models.</p>	<p>We're working on... REF 3798506 – Waterpumps REF 15282595 – Electric brakes REF 15282530 – Switches</p>

* only available in English



Industrial equipment parts and accessories

TVH, more than just forklift parts

Parts for aerial work platforms



Parts for telehandlers and rough-terrain forklifts

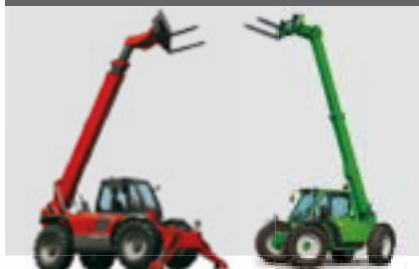

Parts for scrubbers and sweepers



Parts for reachstackers and empty container handling



Parts for terminal/yard tractors



Parts for sideloaders



Parts for people and load carriers



Parts for truck-mounted forklifts



Parts for tow tractors



Parts for tail lifts



Parts for attachments



Parts for handling equipment



For more info, order our new **Industrial equipment parts and accessories brochure (REF 19550200)**



Industrial equipment parts and accessories

TVH, more than just forklift parts

INDUSTRIAL EQUIPMENT PARTS AND ACCESSORIES

Hand pallet trucks, scissor hand pallet trucks and hand trolleys



Manual and electric lift tables



Manual and semi-electric stackers



Rotators

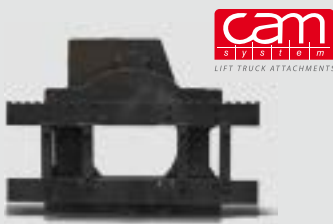

Hydraulic attachments



Sideshifters



Mechanical attachments



Skips, scoops and crane jibs



SmartSweep®, Lazy Sweeper®, Magnetic Sweeper and Hydro Sweeper



Rubber tracks, undercarriage parts, ground support & stabilizer plates



Jacks and supports



Warehouse accessories



For more info, order our new **Industrial equipment parts and accessories brochure (REF 19550200)**



RECONDITIONED PARTS

Buy smart: reconditioned parts



We offer you a **unique range of reconditioned parts**, at the best price.
 Reconditioned parts are sold with the **same warranty** as for a new part, at a price that can be up to 50% cheaper!

Electric motors, thermal engines, printboards, hydraulic pumps, transmissions, torque converters, radiators, steering axles, starters, alternators ... **everything in stock!**

TVH has invested in a wide range of test devices by means of which we can pass stringent quality controls on various spare parts. The tests are designed in such a manner that a realistic work situation is generated during the tests.

Below you can find an overview of our **in-house test equipment**:

- Test setup for hydraulic cylinders
- Test setup for hydraulic valves
- Tester for electric motors
- Linde test truck for hydrostatic transmissions and orbitrols
- Test setup for major and smaller automatic transmissions
- Electronics: functional test, load test, charger tester, measuring equipment
- ...

Buying one of our reconditioned parts is the perfect alternative to buying a new spare part. Ask for the availability and the conditions!
 You can buy a reconditioned part with or without the return of an old unit (service exchange parts):

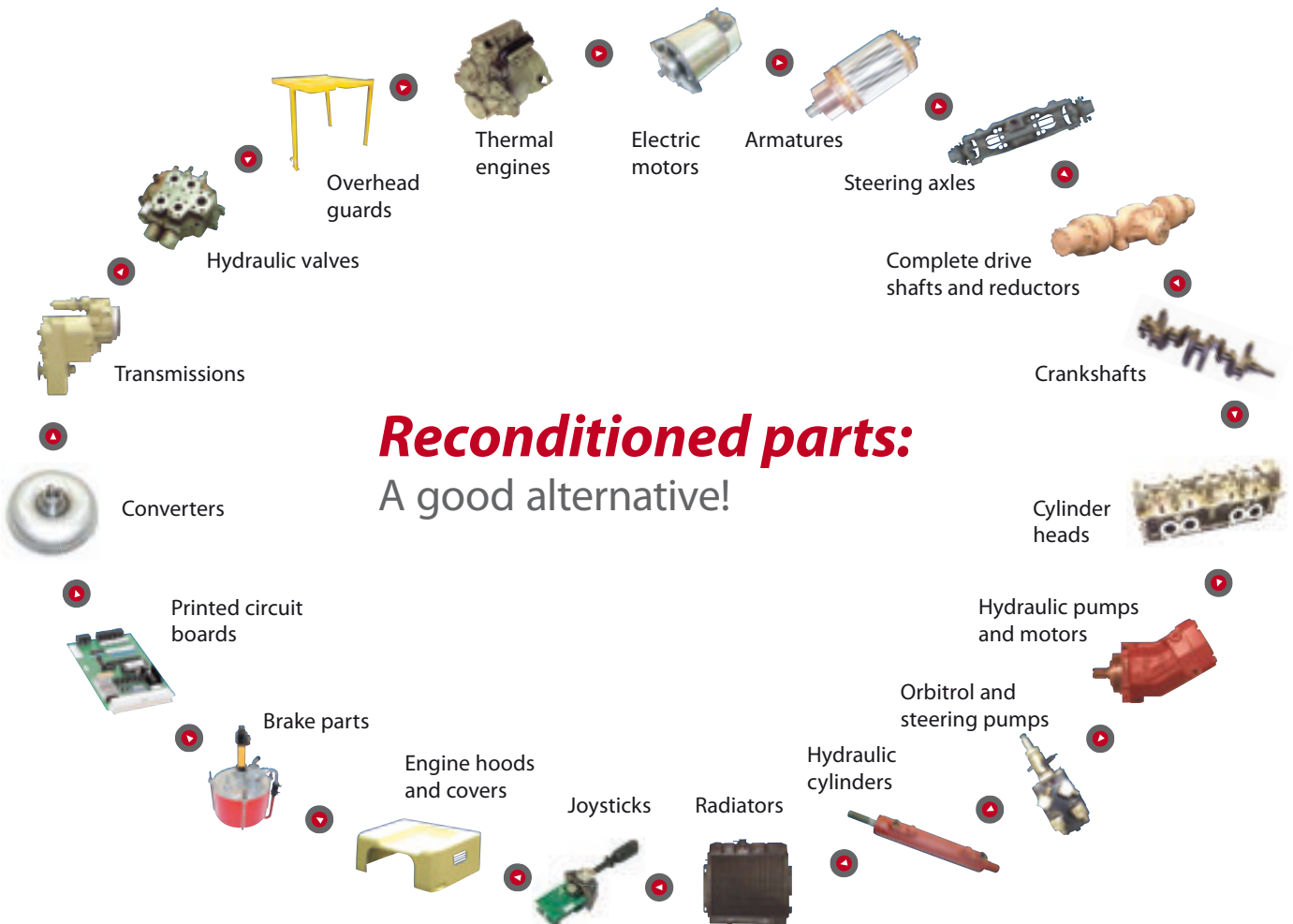



1 Reconditioned part with return of old unit: receive a part and send back your old unit.

In this case, TVH sends you the part you buy, together with a returns note. With the returns note, you can send us your old unit (within 15 days). At TVH, this part is inspected, if the part is approved, TVH sends you a credit note for the surcharge invoice.

- The surcharge invoice will be fully credited if the surcharge unit is repairable.
- You have to use the same packing (box, pallet) in which TVH has sent you the part you bought.
- Transport costs are at the customer's expense; take advantage of our favourable transport conditions.

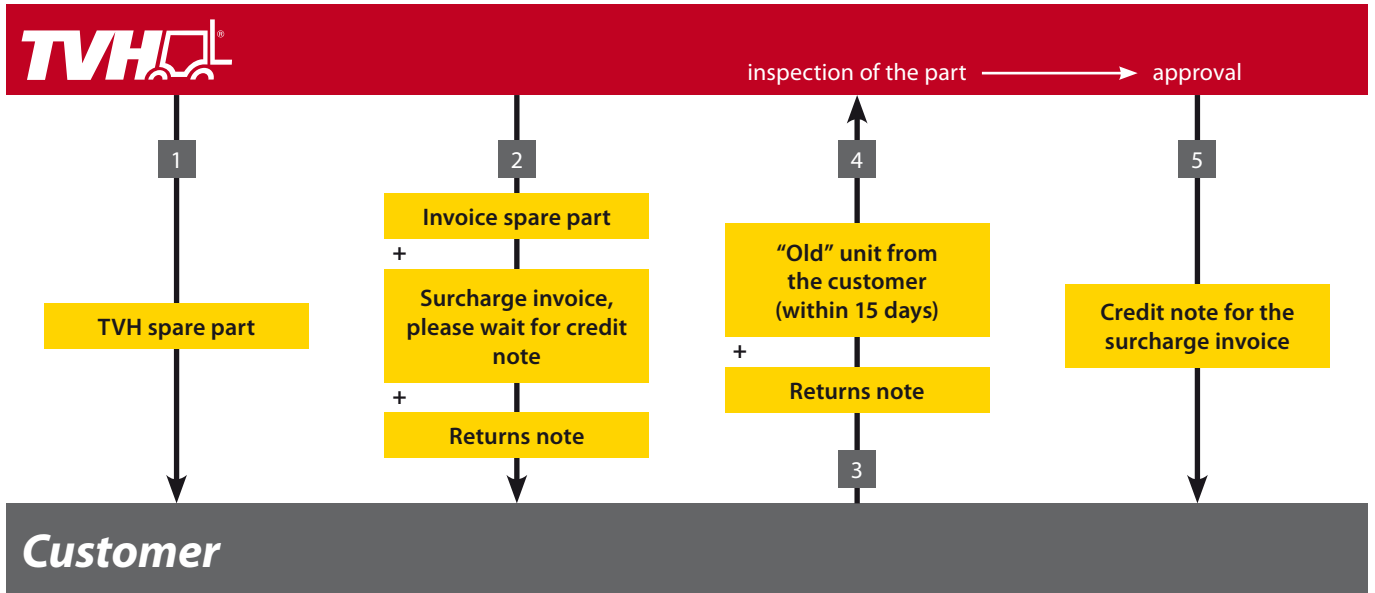

2 Reconditioned part without return of old unit: receive a part without sending back your old unit

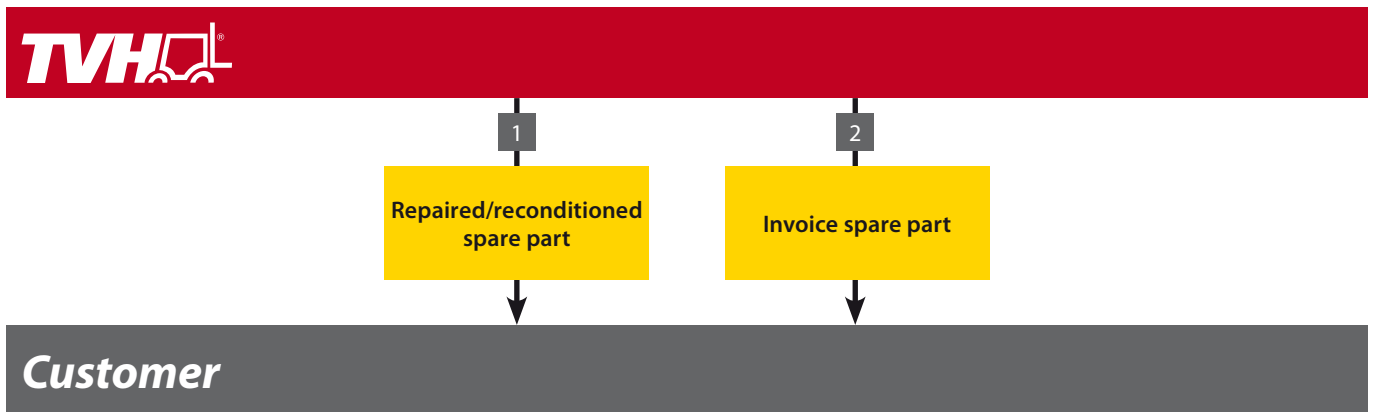

In case your old unit is broken or lost, you can just order a reconditioned part, without returning an old unit. In doubt, just contact your sales team to find the solution that suits your needs best.



TVH-BAY



TVH-bay: TVH's online shop with more than 1000 new and second-hand products at rock bottom prices! Available in 16 languages.

The online shop to pick up real bargains!

- Rock-bottom prices for a limited offer of hard-to-find parts and accessories
- A list of products per brand or product category
- All possible parts and accessories for lift trucks, handling equipment and related products
- All parts are available off the shelf, and can therefore be delivered quickly
- Frequently updated with new references

Go to www.tvh.com/tvhbay now because when it's gone it's gone!

Contact your sales team to order!





MyTotalSource

Your interactive online webshop for spare parts



MYTOTALSOURCE

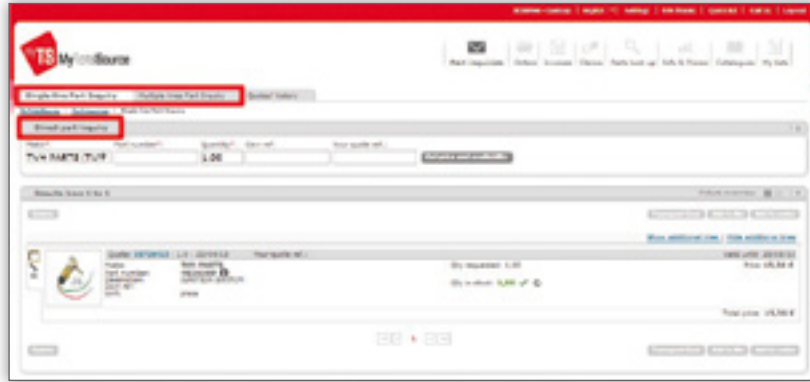

- **Single line part inquiry:** for a quick price and lead time of only 1 item
- **Multiple line part inquiry:** for price and lead time of several parts
- Instant price, availability and picture

View your quotes up to 1 year back in the tab "Quotes' history".

Trace your quote by means of the easy search fields.

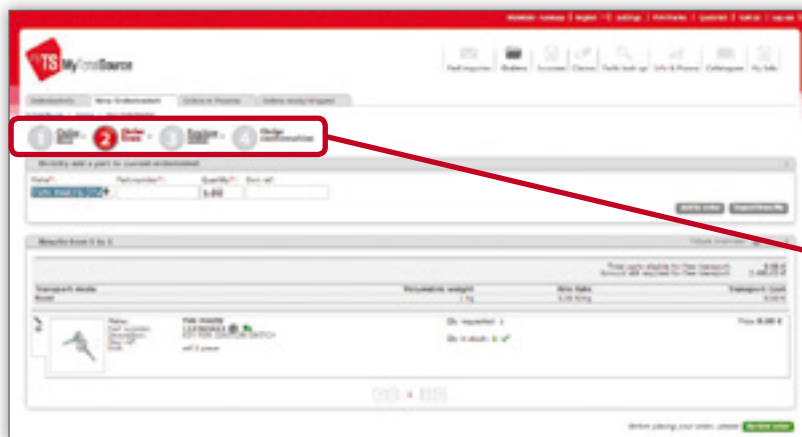
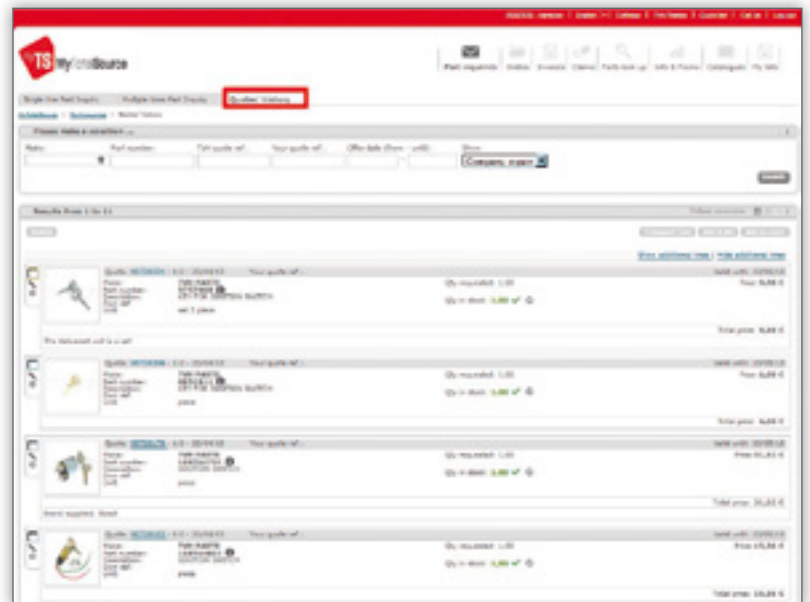

Fast, simple and flexible online ordering of spare parts 24 hours a day

Discover the new 4-step order system

- 1 Create your order basket
- 2 Change your order
- 3 View your order
- 4 Finalize and confirm your order

No login yet? Request your login details now via ecommerce@tvh.com

HELPDESK: T +32 56 43 48 66



MyTotalSource

Your interactive online webshop for spare parts



The user-friendly search modules **MyPartsFinder** (search by brand and truck type) and **MyProductSearch** (search by specifications/technical info) allow you to always find the correct part!

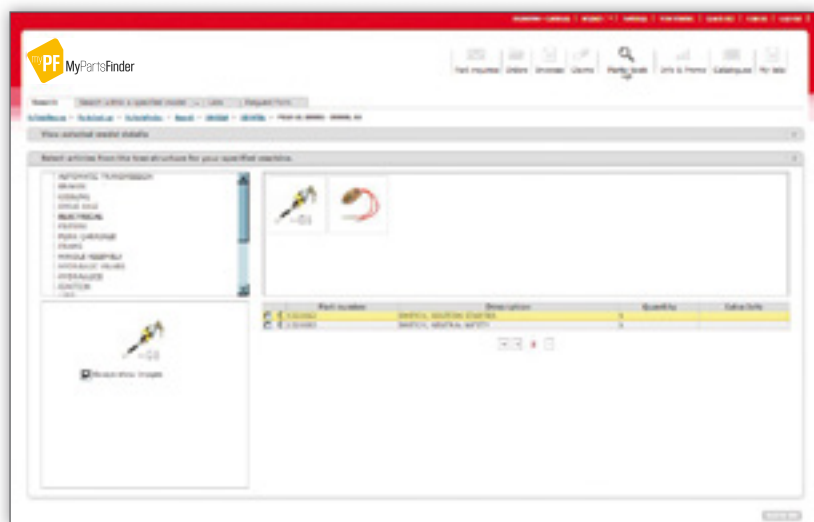

MyPartsFinder
Search parts for every brand based on truck details

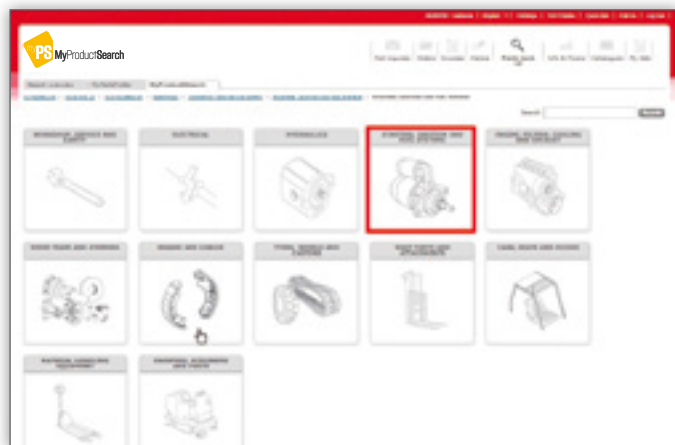

MyProductSearch
Find your product group



MyProductSearch
Find you product

No login yet? Request your login details now via ecommerce@tvh.com

HELPDESK: T +32 56 43 48 66



MyTotalSource

Your interactive online webshop for spare parts



MYTOTALSOURCE



MyProductSearch

Compare. Screens make it possible to narrow down the remaining results.

Easy to lock values you are sure of.



MyProductSearch

Add your selected item to a temporary list by clicking 'Add to list'.

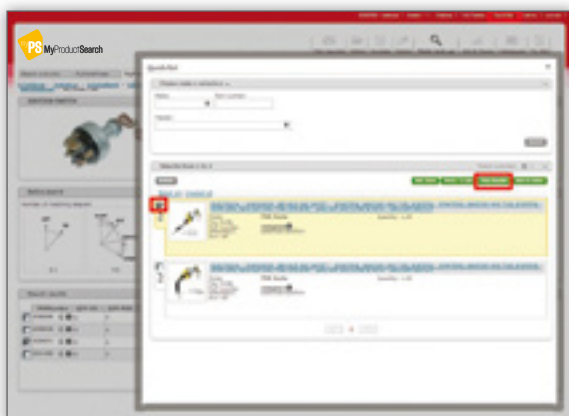

MyProductSearch

Consult all your selected items in the temporary list by clicking 'Quick list'.

Copy your selected items into a price inquiry or order.

No login yet? Request your login details now via ecommerce@tvh.com

HELPDESK: T +32 56 43 48 66



FORKLIFT DIVISION

Used lift trucks and aerial work platforms

A permanent stock of 2100 used machines:

- 1800 used lift trucks & 300 used aerial work platforms
- Telehandler and all-terrain lift trucks
- Subjected to a strict inspection in our workshop
- With our search engine **MyEquipmentFinder** you can find a daily updated list: myequipmentfinder.tvh.com



Jim's Journal

Ask your free copy!

REF [7219304](http://www.tvh.com)



Check our daily updated list: myequipmentfinder.tvh.com



About TVH	I
• TVH History	I
• TVH Worldwide	II
• TVH@social media	III
• References and brands	IV
• Product specials	V
• TVH catalogues	VI
• Industrial equipment parts and accessories	VIII
• Reconditioned parts	X
• TVH-bay	XII
• MyTotalSource	XIII
• Forklift Division	XVI

Key switches **2**

• Technical sheet	2
• Technische fiche	3
• Fiche technique	4
• Technisches datenblatt	5
• Key switches used for:	17
– Allis Chalmers	17
– Atlet - Lafis	22
– Balkancar	24
– Bosch	26
– BT	31
– BV Rocla	44
– Caterpillar	45
– Cesab	56
– Clark	58
– Climax	72
– Crown	75
– Desta	78
– Faba	79
– Fantuzzi	80
– Fenwick - Peg	82
– Fiat - Om Pimespo	86
– Halla - Hyundai	90
– Hamech	93
– Hyster	94
– Icem	105
– JCB	106
– JLG	107
– Jungheinrich	112
– Kalmar	120
– Komatsu	124
– Linde - Lansing	136
– Loc	148
– Lucas	149
– Lugli	152
– Manitou	153
– Mic	159
– Mitsubishi	163
– Mora	175
– Nissan	176
– Nyk - Nichiyu	181
– OMG	183
– Pramac	185
– Prat	186
– Sanderson	187
– Shinko	188
– Sichelsmidt	189
– Steinbock - Boss	190
– Still	195
– SVE Truck	201
– TCM	202
– Toyota	206
– Wagner	216
– Yale	218
– Ignition switches with lever	232

Keys **236**

• Complete range of keys	236
• Safe-T-Lock™ STL 1000	245
• Programmable security lock PSL	246
• Programmable security lock PSL+	246
• Access control system with electronic keys	247



TECHNICAL SHEET

IGNITION SWITCH

Group
02-03-04-00

Example



Customer data

Type machine:

Price inquiry

Serial n° machine:

Order

CODE: QTY-CO x QTY-POS x D1 x NR-SC x TY-CO x L1 x L2 x KEY-PR x TY-POS x KEY-NR x
TVH-KEY x QTY-LI x QTY-PL x QTY-PI x AN-RE x AN-TH x WI-HA

- ... QTY-CO Number of connections.
- ... QTY-POS Number of positions. The first (neutral) position included.
- ... D1 Built-in diameter (mm) (*see p 6*).
- ... NR-SC Number of diagram (*see p 7-10*).
- ... TY-CO Type of connection (*see p 14*):
 - A = blade 4,8 mm
 - B = blade 6,3 mm
 - C = blade 9,5 mm
 - D = pin
 - E = screw
 - F = connector
 - G = solder
 - H = bolt
 - I = connector
- ... L1 Total length (mm) (*see p 6*).
- ... L2 Length of thread (mm) (*see p 6*).
- ... KEY-PR Key present: YES/NO.
- ... TY-POS Key extraction (*see p 11-13*).
- ... KEY-NR Key number.
- ... TVH-KEY TVH-ref of key.
- ... QTY-LI Number of links between connections (*see p 13*).
- ... QTY-PL Number of plugs (*see p 15*).
- ... QTY-PI Number of pins (*see p 15*).
- ... AN-RE Anti-restart: YES/NO.
- ... AN-TH Anti-theft: YES/NO.
- ... WI-HA Wiring harness present (*see p 15*):
 - Y = yes
 - N = no
 - S = separately



TECHNISCHE FICHE CONTACTSLOT

Groep

02-03-04-00

Voorbeeld



Gegevens klant

Type machine:

Prijsaanvraag

Serie nr. machine:

Bestelling

CODE:

QTY-CO x QTY-POS x D1 x NR-SC x TY-CO x L1 x L2 x KEY-PR x TY-POS x KEY-NR x
TVH-KEY x QTY-LI x QTY-PL x QTY-PI x AN-RE x AN-TH x WI-HA

- ... QTY-CO Aantal aansluitingen.
- ... QTY-POS Aantal standen. De eerste (neutrale) stand telt ook mee.
- ... D1 Inbouwdiameter (mm) (zie p 6).
- ... NR-SC Nummer van bijhorende schema (zie p 7-10).
- ... TY-CO Type aansluiting op huis contactslot (zie p 14):
 - A = steker 4,8 mm
 - B = steker 6,3 mm
 - C = steker 9,5 mm
 - D = pin
 - E = vijs
 - F = connector
 - G = soldeerklem
 - H = bout
 - I = fiche
- ... L1 Totale lengte van contactslot, zonder moer (mm) (zie p 6).
- ... L2 Lengte van de schroefdraad (mm) (zie p 6).
- ... KEY-PR Sleutel bijgeleverd: JA/NEE.
- ... TY-POS Sleutel uittrekbaar (zie p 11-13).
- ... KEY-NR Nummer op sleutel.
- ... TVH-KEY TVH-referentie van sleutel.
- ... QTY-LI Aantal links tussen aansluitingen (zie p 13).
- ... QTY-PL Aantal fiches aan kabelboom (zie p 15).
- ... QTY-PI Aantal pinnen aan kabelboom (zie p 15).
- ... AN-RE Anti-herstart: JA/NEE.
- ... AN-TH Antidiefstal: JA/NEE.
- ... WI-HA Kabelboom aanwezig (zie p 15):
 - Y = ja
 - N = nee
 - S = los



FICHE TECHNIQUE CONTACTEUR À CLÉ

Groupe
02-03-04-00

Exemple



Données client

Type machine : Demande de prix

No. série machine : Commande

CODE : QTY-CO x QTY-POS x D1 x NR-SC x TY-CO x L1 x L2 x KEY-PR x TY-POS x KEY-NR x
TVH-KEY x QTY-LI x QTY-PL x QTY-PI x AN-RE x AN-TH x WI-HA

- ... QTY-CO Nombre de connexions.
- ... QTY-POS Nombre de positions. La première position (neutre) compte aussi.
- ... D1 Diamètre de montage (mm) (voir p 6).
- ... NR-SC Numéro illustration (voir p 7-10).
- ... TY-CO Type connexion (voir p 14) :
 - A = cosses 4,8 mm
 - B = cosses 6,3 mm
 - C = cosses 9,5 mm
 - D = axe
 - E = vis
 - F = connecteur
 - G = borne à souder
 - H = boulon
 - I = fiche
- ... L1 Longueur totale (mm) (voir p 6).
- ... L2 Longueur de filetage (mm) (voir p 6).
- ... KEY-PR Clé fournie : OUI/NON.
- ... TY-POS Extraction de clé (voir p 11-13).
- ... KEY-NR Numéro de clé = le numéro indiqué sur la clé.
- ... TVH-KEY Référence TVH de la clé.
- ... QTY-LI Nombre de liaisons entre connexions (voir p 13).
- ... QTY-PL Nombre de fiches au faisceau de câbles (voir p 15).
- ... QTY-PI Nombre d'axes au faisceau de câbles (voir p 15).
- ... AN-RE Anti-redémarrage : OUI/NON.
- ... AN-TH Antivol : OUI/NON.
- ... WI-HA Faisceau de câbles présent (voir p 15) :
 - Y = oui
 - N = non
 - S = détaché



TECHNISCHES DATENBLATT ZÜNDSCHLOSS

Gruppe
02-03-04-00

Beispiel



Kundendaten

Maschinentyp: Preisanfrage

Serien-Nr. Maschine: Bestellung

CODE: QTY-CO x QTY-POS x D1 x NR-SC x TY-CO x L1 x L2 x KEY-PR x TY-POS x KEY-NR x
TVH-KEY x QTY-LI x QTY-PL x QTY-PI x AN-RE x AN-TH x WI-HA

- ... QTY-CO Anzahl der Anschlüsse.
- ... QTY-POS Anzahl der Positionen. Die erste Position (Neutral) eingeschlossen.
- ... D1 Einbaudurchmesser (mm) *(siehe Seite 6)*.
- ... NR-SC Nummer der dazugehörigen Abbildung *(siehe Seite 7-10)*.
- ... TY-CO Anschlussstyp *(siehe Seite 14)*:
 - A = Kabelschuhe 4,8 mm
 - B = Kabelschuhe 6,3 mm
 - C = Kabelschuhe 9,5 mm
 - D = Steckeranschluss
 - E = Schraubanschluss
 - F = Verbindungsstecker
 - G = Anlöten
 - H = Schrauben mit Mutter
 - I = Stecker
- ... L1 Gesamtlänge (mm) *(siehe Seite 6)*.
- ... L2 Gewindelänge (mm) *(siehe Seite 6)*.
- ... KEY-PR Schlüssel wird mitgeliefert: JA/NEIN.
- ... TY-POS Schlüssel abziehbar *(siehe Seite 11-13)*.
- ... KEY-NR Schlüsselnummer.
- ... TVH-KEY TVH-Referenz des Schlüssels.
- ... QTY-LI Anzahl der Verbindungen zwischen den Anschlüssen *(siehe Seite 13)*.
- ... QTY-PL Anzahl der Stecker am Kabelbaum *(siehe Seite 15)*.
- ... QTY-PI Anzahl Anschlüsse an Kabelbaum *(siehe Seite 15)*.
- ... AN-RE Anti-Neustart: JA/NEIN.
- ... AN-TH Anti-Diebstahl: JA/NEIN.
- ... WI-HA Kabelbaum vorhanden *(siehe Seite 15)*:
 - Y = Ja
 - N = Nein
 - S = Separat



KEY SWITCHES

For all our latest catalogue updates and company info: www.tvh.com

Dimensions / Afmetingen / Abmessungen

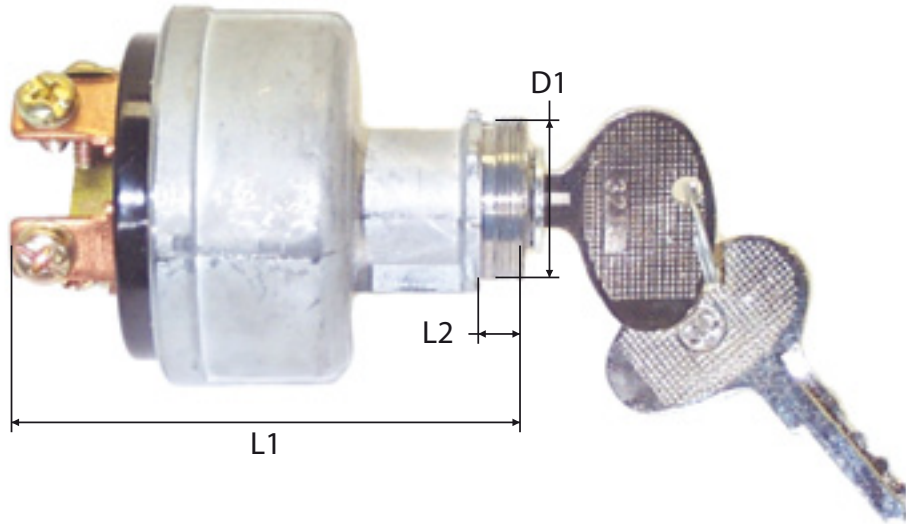



Diagrams / Schema's / Schémas / Abbildung

2.1

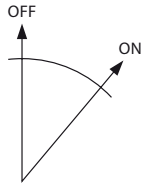

2.2

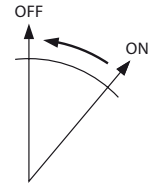

3.1

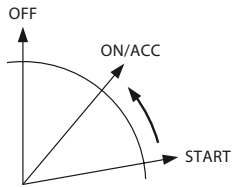

3.2

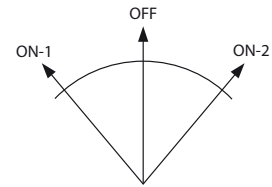

3.3

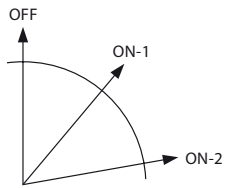

3.4

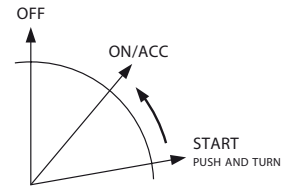

3.5

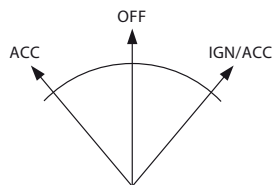

3.6

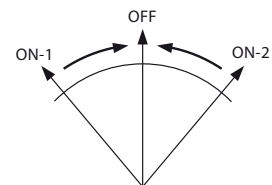



KEY SWITCHES

For all our latest catalogue updates and company info: www.tvh.com

Diagrams / Schema's / Schémas / Abbildung

3.7

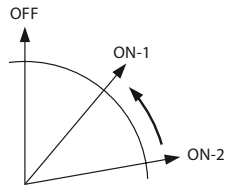

3.8

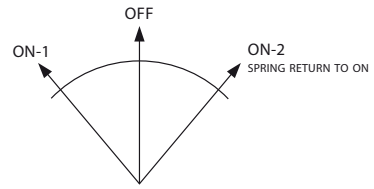

4.1

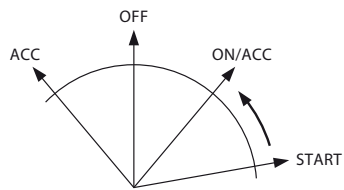

4.2

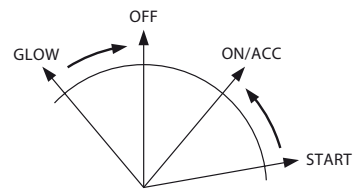

4.3

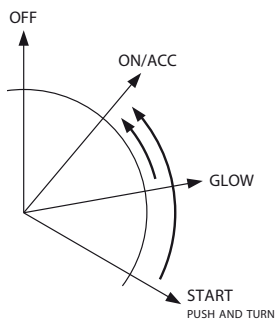

4.4

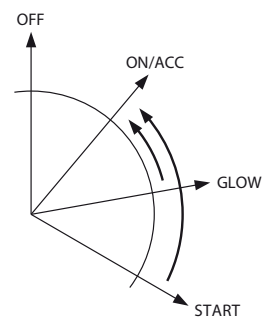

4.5

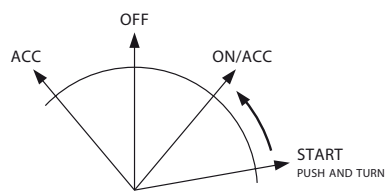

4.6

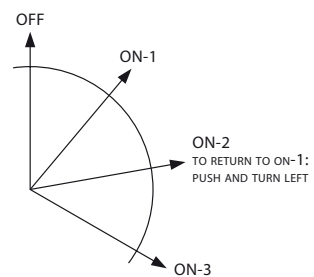



Diagrams / Schema's / Schémas / Abbildung

4.7

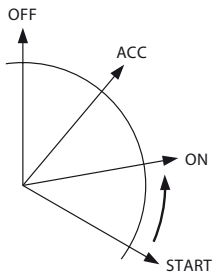

4.8

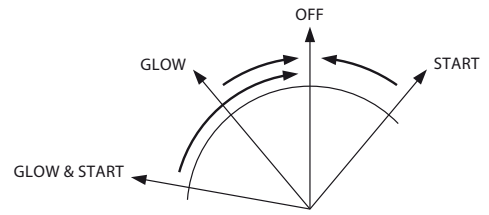

4.9

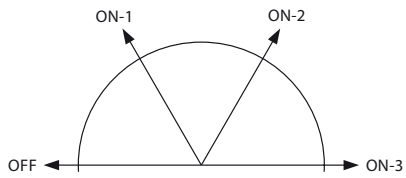

5.1

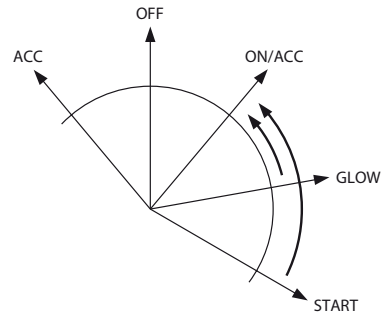

5.2

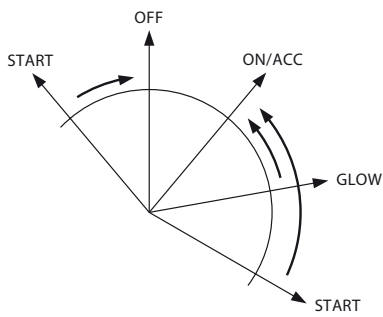

5.3

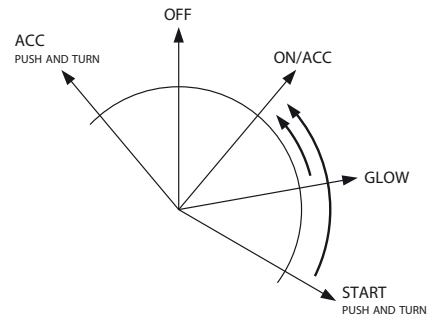

5.4

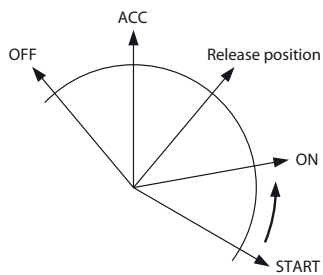

5.5

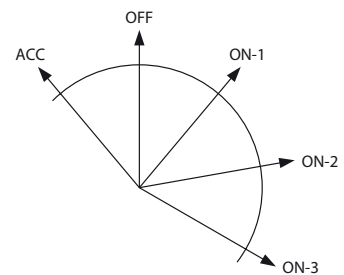



KEY SWITCHES

For all our latest catalogue updates and company info: www.tvh.com

Diagrams / Schema's / Schémas / Abbildung

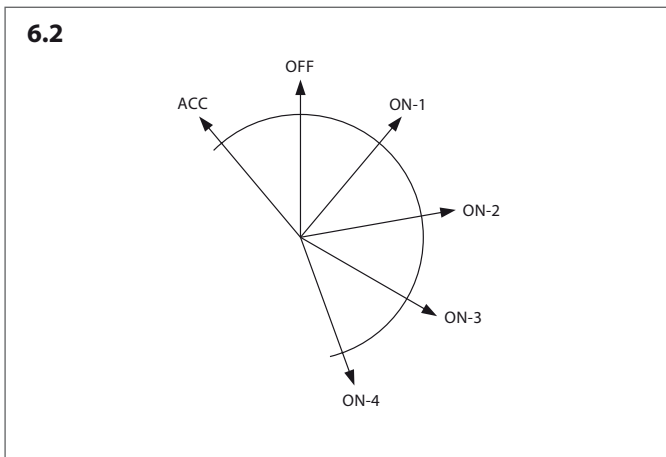
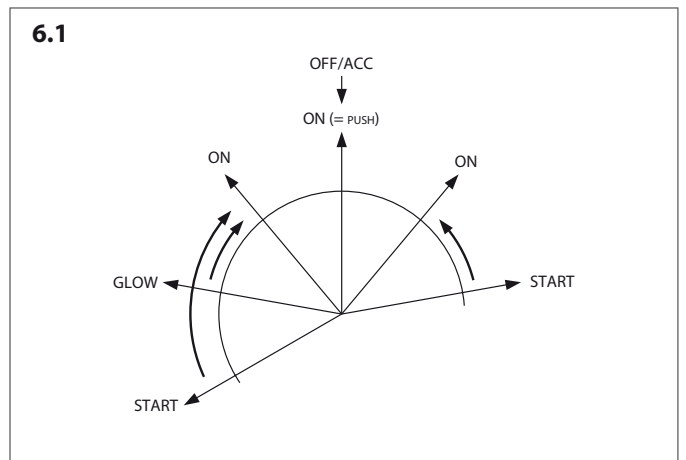
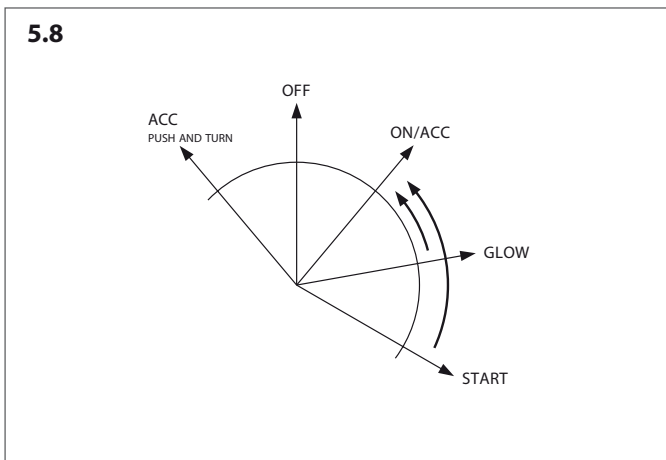
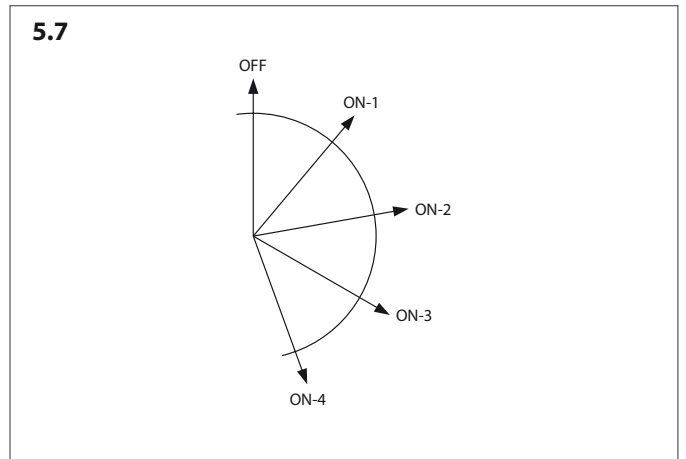
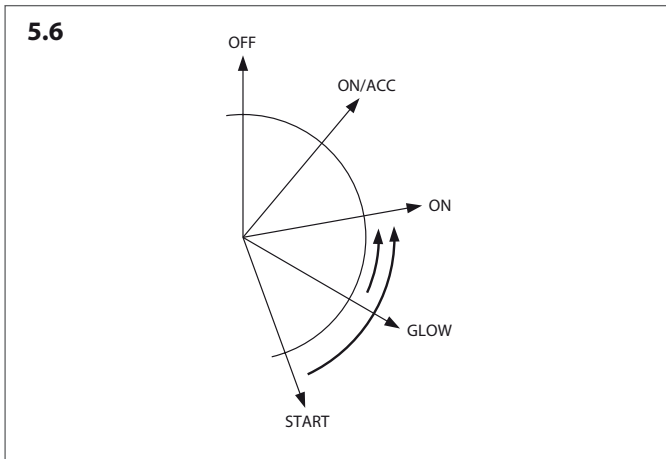



Key extraction / Sleutel uittrekbaar / Extraction de clé / Schlüssel abziehbar



TY-POS = 2

2A

2B

2C

2D

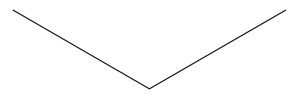
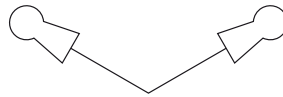
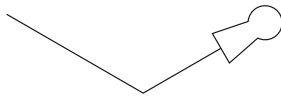
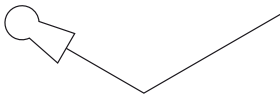

TY-POS = 3

3A

3B

3C

3D

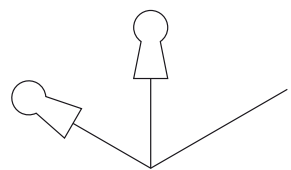
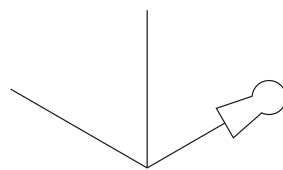
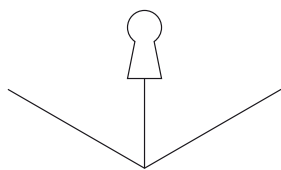
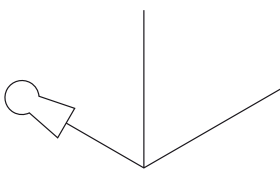

3E

3F

3G

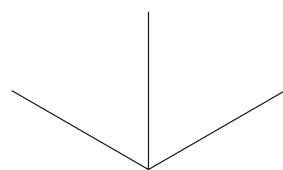
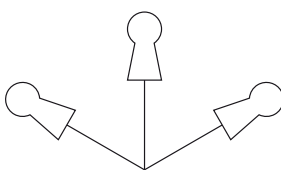
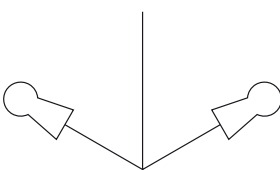



KEY SWITCHES

For all our latest catalogue updates and company info: www.tvh.com

Key extraction / Sleutel uittrekbaar / Extraction de clé / Schlüssel abziehbar

TY-POS = 4

4A

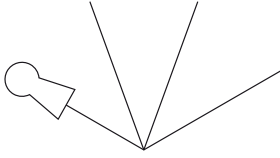

4B

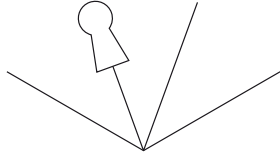

4C

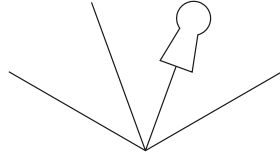

4D

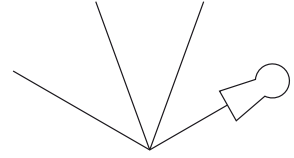

4E

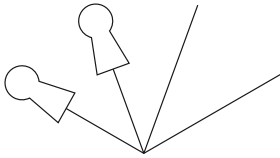

4F

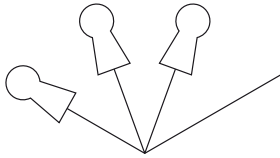

4G

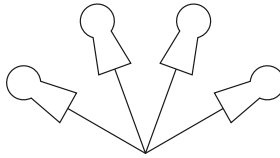

4H

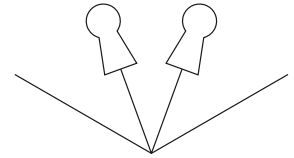

4I

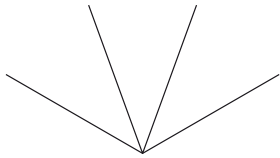

TY-POS = 5

5A

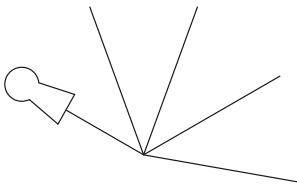

5B

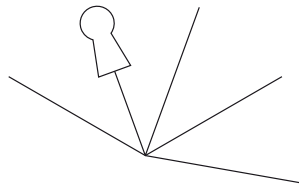

5C

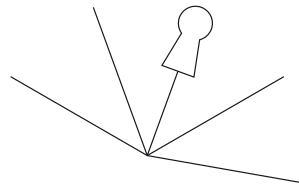

5D

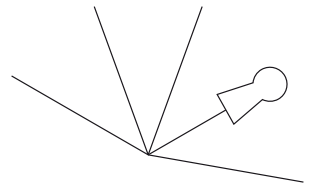

5E

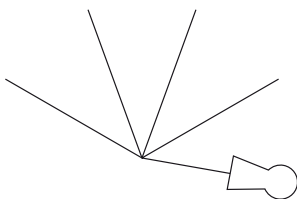

5F

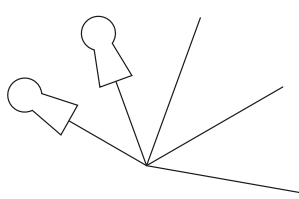

5G

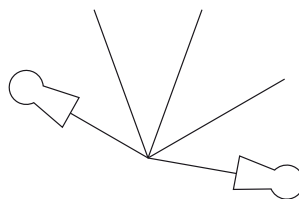



Key extraction / Sleutel uittrekbaar / Extraction de clé / Schlüssel abziehbar

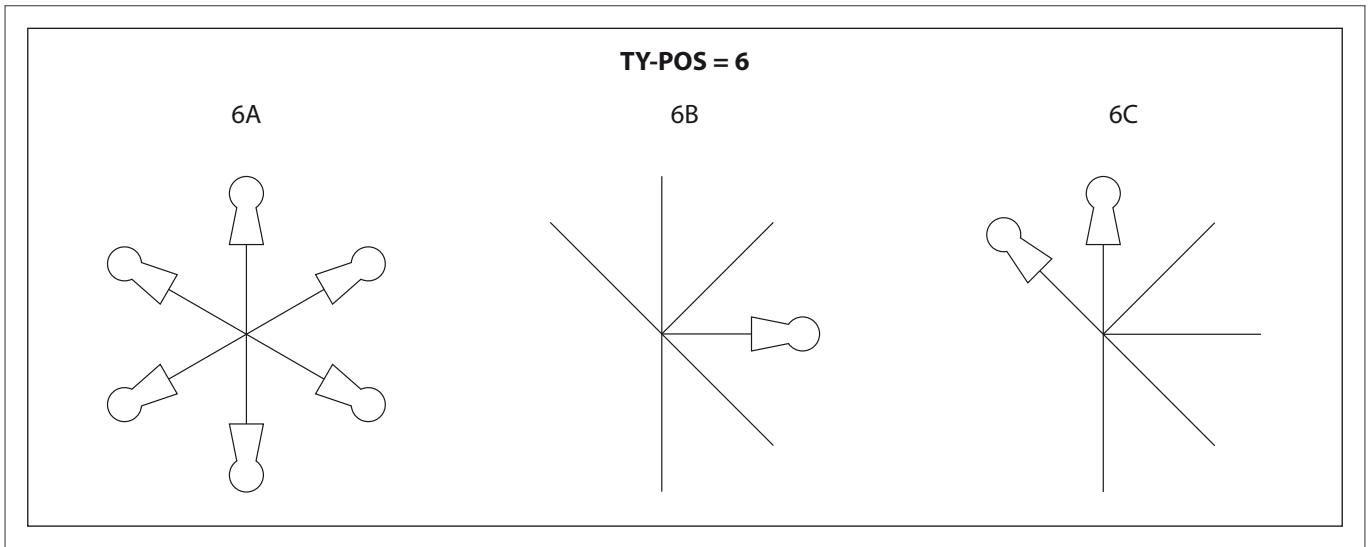

Number of links between connections / Aantal links tussen aansluitingen / Nombre de liaisons entre connexions / Anzahl der Verbindungen zwischen den Anschlüssen





KEY SWITCHES

For all our latest catalogue updates and company info: www.tvh.com

Type of connection / Type aansluiting / Type connexion / Anschlusstyp

Type / Typ A

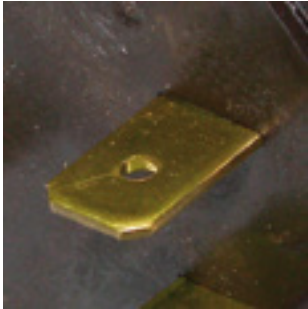

Type / Typ B



Type / Typ C



Type / Typ D



Type / Typ E



Type / Typ F



Type / Typ G



Type / Typ H



Type / Typ I



In case of a combination of different connections, please state in alphabetical order.

Bij combinatie van verschillende aansluitingen, plaats deze combinaties in alfabetische volgorde.

En cas de combinaison de plusieurs connexions, placer ces combinaisons en ordre alphabétique.

Bei Kombination unterschiedlicher Anschlüsse, nehmen Sie die dazugehörigen Typen, und ordnen Sie diese alphabetisch.



What are plugs? / Wat zijn fiches? / Que sont les fiches ? / Was sind Stecker?

All insulated pins, connectors and connections.

Alle geïsoleerde pinnen, connectoren en zekeringhouders.

Tous les axes, connecteurs et porte-fusibles isolés.

Alle isolierte Stecker, Verbindungen und Sicherungshalter.



What are pins? / Wat zijn pinnen? / Que sont les axes ? / Was sind Anschlüsse?

All non-insulated connections.

Alle niet-geïsoleerde aansluitingen.

Toutes les connexions non isolées.

Alle nicht-isolierte Anschlüsse.



Fixed wire harness / Vaste kabelboom / Faisceau de câbles fixe / Fester Kabelbaum

In case of a fixed wiring harness, count only the number of pins and plugs at the end of the cable. In case of a loose cables, count all pins and plugs.

Bij het tellen van het aantal fiches en pinnen op een vaste kabel zijn enkel diegene op het uiteinde van belang. Bij een losse kabel zijn deze allemaal meegerekend.

En comptant le nombre de fiches et d'axes sur un câble fixe, seules celles à l'extrémité sont importantes. En cas d'un câble détaché, elles sont toutes comptées.

Bei dem zählen von der Anzahl Stecker und Anschlüsse auf einem Kabel sind nur die wichtig am Ende des Kabels. Bei einem lockeren Kabel muss man alle mitrechnen.



KEY SWITCHES

For all our latest catalogue updates and company info: www.tvh.com



KEY SWITCHES USED FOR ALLIS CHALMERS

Number of connections	Number of positions	Dia (mm)	Total length (mm)	Type connection	Anti-restart	Key number	TVH-ref of key	REF switch with key	
QTY-CO	QTY-POS	D1	L1	TY-CO	AN-RE	KEY-NR	TVH-KEY		
2	2	15	53	H	no	684	108TA4988	110TA7741	
2	2	16	63	E	no	83357	129TA4185	110TA8026	
2	2	19	43	B	no	2007	128TA5726	123TA5682	
2	2	25	55	E	no	31131	108TA5021	141TA2614	
2	3	25	55	E	no			141TA2799	
3	2	19	42	G	no			141TA3165	

2.1

2A

REF [110TA7741](#)

2.1

2A

REF [110TA8026](#)

2.1

2A

REF [123TA5682](#)

2.1

2A

REF [141TA2614](#)

3.1

3A

REF [141TA2799](#)

2.1

2A

REF [141TA3165](#)

If key number is not mentioned, there is no reference on the key or the key switch is supplied with different key numbers.



KEY SWITCHES

For all our latest catalogue updates and company info: www.tvh.com

KEY SWITCHES USED FOR ALLIS CHALMERS

Number of connections	Number of positions	Dia (mm)	Total length (mm)	Type connection	Anti-restart	Key number	TVH-ref of key	REF switch with key	
QTY-CO	QTY-POS	D1	L1	TY-CO	AN-RE	KEY-NR	TVH-KEY		
3	2	21	40	G	no	A126	128TA5701	123TA5683	
3	3	16	65	E	no	83357	129TA4185	141TA2870	
3	3	16	80	B	no			123TA5685	
3	3	22	52	B	yes			128TA5522	
4	2	26	78	BC	no	14603	141TA2654	141TA2962	
4	4	19	70	H	yes			141TA3068	

2.1

2A

REF [123TA5683](#)

3.2

3F

REF [141TA2870](#)

3.1

3G

REF [123TA5685](#)

3.1

3A

REF [128TA5522](#)

2.1

2A

REF [141TA2962](#)

4.1

4I

REF [141TA3068](#)

If key number is not mentioned, there is no reference on the key or the key switch is supplied with different key numbers.

KEY SWITCHES

For all our latest catalogue updates and company info: www.tvh.com



KEY SWITCHES USED FOR ALLIS CHALMERS

Number of connections	Number of positions	Dia (mm)	Total length (mm)	Type connection	Anti-restart	Key number	TVH-ref of key	REF switch with key		
QTY-CO	QTY-POS	D1	L1	TY-CO	AN-RE	KEY-NR	TVH-KEY			
4	4	19	79	H	no	E30		108TA4825		
4	4	25	62	E	yes			110TA3256		141TA2775
5	2	22	56	B	no			108TA4994		128TA5585
5	3	25	62	E	yes					123TA5686
5	4	25	64	E	yes					110TA8282
6	3	20	71	B	yes	U7800	128TA5782	141TA2881		

4.1

4B

REF [108TA4825](#)

4.1

4B

REF [141TA2775](#)

2.1

2A

REF [128TA5585](#)

3.1

3A

REF [123TA5686](#)

4.1

4B

REF [110TA8282](#)

3.1

3A

REF [141TA2881](#)

If key number is not mentioned, there is no reference on the key or the key switch is supplied with different key numbers.



KEY SWITCHES

For all our latest catalogue updates and company info: www.tvh.com

KEY SWITCHES USED FOR ALLIS CHALMERS

Number of connections	Number of positions	Dia (mm)	Total length (mm)	Type connection	Anti-restart	Key number	TVH-ref of key	REF switch with key	
QTY-CO	QTY-POS	D1	L1	TY-CO	AN-RE	KEY-NR	TVH-KEY		
6	3	20	71	B	yes	U7800	128TA5782	141TA3118	
6	4	19	96	E	no			123TA5689	
6	4	20	72	F	no	648	108TA5023	141TA2892	
6	4	20	72	E	no	100	108TA5022	141TA3137	
6	4	20	72	E	no	100	108TA5022	141TA3106	
6	4	20	74	E	no	001	108TA4990	141TA2945	

type of plug

3.1

3A

REF [141TA3118](#)

4.2

4B

REF [123TA5689](#)

type of plug

4.2

4B

REF [141TA2892](#)

type of plug

4.2

4B

REF [141TA3137](#)

type of plug

4.2

4B

REF [141TA3106](#)

type of plug

4.2

4B

REF [141TA2945](#)

If key number is not mentioned, there is no reference on the key or the key switch is supplied with different key numbers.

KEY SWITCHES

For all our latest catalogue updates and company info: www.tvh.com



KEY SWITCHES USED FOR ALLIS CHALMERS

Number of connections	Number of positions	Dia (mm)	Total length (mm)	Type connection	Anti-restart	Key number	TVH-ref of key	REF switch with key	
QTY-CO	QTY-POS	D1	L1	TY-CO	AN-RE	KEY-NR	TVH-KEY		
6	4	20	74	E	no	001	108TA4990	141TA2966	
6	4	20	74	E	no	001	108TA4990	141TA2988	
6	4	20	80	F	no	648	108TA5023	141TA2899	
6	4	20	85	E	no	648	108TA5023	141TA2814	
6	4	20	86	E	no			141TA3034	

type of plug

4.2

4B

REF [141TA2966](#)

type of plug

4.2

4B

REF [141TA2988](#)

type of plug

4.2

4B

REF [141TA2899](#)

type of plug

4.2

4B

REF [141TA2814](#)

4.2

4B

REF [141TA3034](#)

If key number is not mentioned, there is no reference on the key or the key switch is supplied with different key numbers.



KEY SWITCHES

For all our latest catalogue updates and company info: www.tvh.com

KEY SWITCHES USED FOR ATLET - LAFIS

Number of connections	Number of positions	Dia (mm)	Total length (mm)	Type connection	Anti-restart	Key number	TVH-ref of key	REF switch with key	
QTY-CO	QTY-POS	D1	L1	TY-CO	AN-RE	KEY-NR	TVH-KEY		
2	2	19	52	G	no	9471	141TA2657	141TA2862	
2	2	22	57	E	no			108TA4849	
3	2	22	49	B	no	301	108TA5004	128TA5608	
3	2	22	56	G	no			141TA2597	
3	3	18	65	B	no	14644	108TA5013	141TA2789	
3	3	22	52	B	yes	K11	108TA5017	128TA5554	

REF [141TA2862](#)

2.1

2C

REF [108TA4849](#)

2.1

2A

REF [128TA5608](#)

2.1

2A

REF [141TA2597](#)

2.1

2A

REF [141TA2789](#)

3.3

3A

REF [128TA5554](#)

3.1

3A

If key number is not mentioned, there is no reference on the key or the key switch is supplied with different key numbers.

KEY SWITCHES

For all our latest catalogue updates and company info: www.tvh.com



KEY SWITCHES USED FOR ATLET - LAFIS

Number of connections	Number of positions	Dia (mm)	Total length (mm)	Type connection	Anti-restart	Key number	TVH-ref of key	REF switch with key	
QTY-CO	QTY-POS	D1	L1	TY-CO	AN-RE	KEY-NR	TVH-KEY		
4	2	19	37	G	no			128TA5841	
4	3	19	55	B	no			110TA8043	
5	2	22	56	B	no			108TA4664	
5	2	22	56	B	no	E30	108TA4994	141TA2763	

2.1

2A

REF [128TA5841](#)

3.2

3B

REF [110TA8043](#)

2.1

2A

REF [108TA4664](#)

2.1

2A

REF [141TA2763](#)

If key number is not mentioned, there is no reference on the key or the key switch is supplied with different key numbers.





KEY SWITCHES

For all our latest catalogue updates and company info: www.tvh.com

KEY SWITCHES USED FOR BALKANCAR

Number of connections	Number of positions	Dia (mm)	Total length (mm)	Type connection	Anti-restart	Key number	TVH-ref of key	REF switch with key	
QTY-CO	QTY-POS	D1	L1	TY-CO	AN-RE	KEY-NR	TVH-KEY		
4	2	30	80	E	no	3095	122TA8983	141TA3145	
4	2	30	82	E	no	3095	129TA4021	108TA4900	
6	4	16	65	BC	no	LUCAS	141TA2658	110TA9032	
6	4	16	66	BC	no			141TA2601	
6	4	20	71	BC	no			128TA5794	
8	3	22	50	B	no			128TA5787	







2.1



2A

REF [141TA3145](#)







2.1



2C

REF [108TA4900](#)







4.4



4A

REF [110TA9032](#)







4.4



4A

REF [141TA2601](#)





4.4



4A

REF [128TA5794](#)



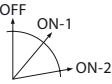

3.3



3A

REF [128TA5787](#)

If key number is not mentioned, there is no reference on the key or the key switch is supplied with different key numbers.

KEY SWITCHES

For all our latest catalogue updates and company info: www.tvh.com

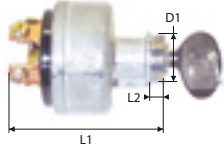

KEY SWITCHES USED FOR BALKANCAR

Number of connections	Number of positions	Dia (mm)	Total length (mm)	Type connection	Anti-restart	Key number	TVH-ref of key	REF switch with key	
QTY-CO	QTY-POS	D1	L1	TY-CO	AN-RE	KEY-NR	TVH-KEY		
10	5	22	49	B	no			141TA2499	





5.7



5G

REF [141TA2499](#)

If key number is not mentioned, there is no reference on the key or the key switch is supplied with different key numbers.



KEY SWITCHES

For all our latest catalogue updates and company info: www.tvh.com

KEY SWITCHES USED FOR BOSCH

Number of connections	Number of positions	Dia (mm)	Total length (mm)	Type connection	Anti-restart	Key number	TVH-ref of key	REF switch with key	
QTY-CO	QTY-POS	D1	L1	TY-CO	AN-RE	KEY-NR	TVH-KEY		
3	2	26	41	E	no	E30 BOSCH K11	115TA5398	115TA5388	
3	3	22	52	B	yes		106TA2652	106TA2652	
3	3	22	52	B	yes		141TA2659	109TA5971	
3	3	22	52	B	yes		108TA5017	106TA2653	
3	3	22	52	B	no		108TA5026	128TA5636	
3	3	22	52	B	yes	108TA5026	141TA2824		

REF [115TA5388](#)

2.1

2A

REF [106TA2652](#)

3.1

3A

REF [109TA5971](#)

3.1

3A

REF [106TA2653](#)

3.1

3A

REF [128TA5636](#)

3.1

3A

REF [141TA2824](#)

3.1

3A

If key number is not mentioned, there is no reference on the key or the key switch is supplied with different key numbers.

KEY SWITCHES

For all our latest catalogue updates and company info: www.tvh.com



KEY SWITCHES USED FOR BOSCH

Number of connections	Number of positions	Dia (mm)	Total length (mm)	Type connection	Anti-restart	Key number	TVH-ref of key	REF switch with key	
QTY-CO	QTY-POS	D1	L1	TY-CO	AN-RE	KEY-NR	TVH-KEY		
5	2	22	56	B	no			106TA2642	
5	2	22	56	B	no	E30	108TA4994	109TA5974	
5	2	22	56	B	no	E41	108TA4995	109TA5973	
5	2	22	56	B	no	K03	108TA4996	106TA2643	
5	3	22	65	E	no	U39	128TA5797	128TA5796	
5	4	22	59	E	yes	E30	108TA4994	106TA2649	

2.1

2A

REF [106TA2642](#)

2.1

2A

REF [109TA5974](#)

2.1

2A

REF [109TA5973](#)

2.1

2A

REF [106TA2643](#)

3.1

3A

REF [128TA5796](#)

4.5

4B

REF [106TA2649](#)

If key number is not mentioned, there is no reference on the key or the key switch is supplied with different key numbers.



KEY SWITCHES

For all our latest catalogue updates and company info: www.tvh.com

KEY SWITCHES USED FOR BOSCH

Number of connections	Number of positions	Dia (mm)	Total length (mm)	Type connection	Anti-restart	Key number	TVH-ref of key	REF switch with key	
QTY-CO	QTY-POS	D1	L1	TY-CO	AN-RE	KEY-NR	TVH-KEY		
5	4	22	59	E	yes			106TA2647	
5	4	22	65	E	yes	E30	108TA4994	106TA2656	
5	6	26	65	E	no	14610	108TA5033	141TA2430	
6	3	22	65	B	no	E80	108TA5005	109TA5970	
6	3	25	49	BE	no		108TA5034	128TA5631	
6	3	26	56	E	no		129TA3544	106TA2644	

4.5

4B

REF [106TA2647](#)

4.3

4A

REF [106TA2656](#)

6.2

6C

REF [141TA2430](#)

3.1

3A

REF [109TA5970](#)

3.3

3A

REF [128TA5631](#)

3.3

3F

REF [106TA2644](#)

If key number is not mentioned, there is no reference on the key or the key switch is supplied with different key numbers.

KEY SWITCHES

For all our latest catalogue updates and company info: www.tvh.com



KEY SWITCHES USED FOR BOSCH

Number of connections	Number of positions	Dia (mm)	Total length (mm)	Type connection	Anti-restart	Key number	TVH-ref of key	REF switch with key	
QTY-CO	QTY-POS	D1	L1	TY-CO	AN-RE	KEY-NR	TVH-KEY		
6	4	15	59	B	yes			128TA5849	
6	4	22	55	B	yes	K10	141TA2660	141TA2481	
6	4	22	56	B	no	U39	128TA5797	141TA2483	
6	4	22	59	B	yes			106TA2648	
6	4	22	59	B	yes	K30	108TA5014	106TA2651	
6	5	26	61	BC	no	14610	108TA5033	110TA8177	

ACC OFF ON/ACC
START
PUSH AND TURN

4.5

4B

REF [128TA5849](#)

ACC OFF ON/ACC
START
PUSH AND TURN

4.5

4B

REF [141TA2481](#)

ACC OFF ON/ACC
START
PUSH AND TURN

4.5

4B

REF [141TA2483](#)

ACC OFF ON/ACC
START
PUSH AND TURN

4.5

4B

REF [106TA2648](#)

ACC OFF ON/ACC
START
PUSH AND TURN

4.5

4B

REF [106TA2651](#)

ACC OFF ON-1
ON-2
ON-3

5.5

5F

REF [110TA8177](#)

If key number is not mentioned, there is no reference on the key or the key switch is supplied with different key numbers.



KEY SWITCHES

For all our latest catalogue updates and company info: www.tvh.com

KEY SWITCHES USED FOR BOSCH

Number of connections	Number of positions	Dia (mm)	Total length (mm)	Type connection	Anti-restart	Key number	TVH-ref of key	REF switch with key	
QTY-CO	QTY-POS	D1	L1	TY-CO	AN-RE	KEY-NR	TVH-KEY		
7	4	26	51	E	no	K80	129TA3543	106TA2645	
7	4	26	51	BE	no		129TA3543	106TA2646	
7	4	26	51	E	yes		109TA5981	109TA5979	
10	5	22	65	B	yes		108TA5029	106TA2655	
10	5	22	65	B	yes			106TA2654	

4.6

4G

REF [106TA2645](#)

4.6

4G

REF [106TA2646](#)

4.6

4G

REF [109TA5979](#)

5.3

5F

REF [106TA2655](#)

5.3

5F

REF [106TA2654](#)

If key number is not mentioned, there is no reference on the key or the key switch is supplied with different key numbers.

KEY SWITCHES

For all our latest catalogue updates and company info: www.tvh.com



KEY SWITCHES USED FOR BT

Number of connections	Number of positions	Dia (mm)	Total length (mm)	Type connection	Anti-restart	Key number	TVH-ref of key	REF switch with key	
QTY-CO	QTY-POS	D1	L1	TY-CO	AN-RE	KEY-NR	TVH-KEY		
2	2	16	48	B	no	633	108TA5011	141TA2699	
2	2	18	43	B	no		140TA1399	140TA1399	
2	2	19	43	B	no	2007	128TA5726	123TA5690	
2	2	19	60	B	no	F315	129TA4029	141TA2487	
2	2	20	71	E	no	NG100	129TA4188	141TA3127	
2	2	22	57	E	no		128TA5609	128TA5609	

2.1

2A

REF [141TA2699](#)

2.1

2A

REF [140TA1399](#)

2.1

2A

REF [123TA5690](#)

2.1

2A

REF [141TA2487](#)

2.1

2A

REF [141TA3127](#)

2.1

2A

REF [128TA5609](#)

If key number is not mentioned, there is no reference on the key or the key switch is supplied with different key numbers.



KEY SWITCHES

For all our latest catalogue updates and company info: www.tvh.com

KEY SWITCHES USED FOR BT

Number of connections	Number of positions	Dia (mm)	Total length (mm)	Type connection	Anti-restart	Key number	TVH-ref of key	REF switch with key	
QTY-CO	QTY-POS	D1	L1	TY-CO	AN-RE	KEY-NR	TVH-KEY		
2	2	22	67	E	no	KN101	110TA3541	141TA2769	
2	2	22	62	E	no	455	108TA4991	128TA5612	
2	2	22	53	B	no			141TA2498	
2	2	22	51	F	no			128TA5828	
3	2	19	34	G	no	606		141TA2607	
3	2	19	40	G	no	002	129TA3940	115TA5391	

REF [141TA2769](#)

2.1

2A

REF [128TA5612](#)

2.1

2A

REF [141TA2498](#)

2.1

2A

REF [128TA5828](#)

2.1

2A

REF [141TA2607](#)

2.1

2A

REF [115TA5391](#)

2.1

2A

If key number is not mentioned, there is no reference on the key or the key switch is supplied with different key numbers.

KEY SWITCHES

For all our latest catalogue updates and company info: www.tvh.com



KEY SWITCHES USED FOR BT

Number of connections	Number of positions	Dia (mm)	Total length (mm)	Type connection	Anti-restart	Key number	TVH-ref of key	REF switch with key	
QTY-CO	QTY-POS	D1	L1	TY-CO	AN-RE	KEY-NR	TVH-KEY		
3	2	19	40	G	no	003	129TA3933	116TA5645	
3	2	20	54	B	no			141TA2751	
3	2	21	40	G	no	A126	128TA5701	108TA4565	
3	2	22	44	B	no			108TA8314	
3	2	22	47	B	no	702	106TA2629	141TA3060	
3	2	22	47	B	no	701	108TA4993	141TA2842	

REF [116TA5645](#)

2.1

2A

REF [141TA2751](#)

2.1

2A

REF [108TA4565](#)

2.1

2A

REF [108TA8314](#)

2.1

2A

REF [141TA3060](#)

2.1

2A

REF [141TA2842](#)

2.1

2A

If key number is not mentioned, there is no reference on the key or the key switch is supplied with different key numbers.



KEY SWITCHES

For all our latest catalogue updates and company info: www.tvh.com

KEY SWITCHES USED FOR BT

Number of connections	Number of positions	Dia (mm)	Total length (mm)	Type connection	Anti-restart	Key number	TVH-ref of key	REF switch with key	
QTY-CO	QTY-POS	D1	L1	TY-CO	AN-RE	KEY-NR	TVH-KEY		
3	2	22	48	B	no	530	106TA2637	141TA2729	
3	2	22	48	B	no	501	106TA2631	141TA2959	
3	2	22	48,5	B	no	702	108TA4992	141TA2903	
3	2	22	49	B	no	503	106TA2635	141TA2697	
3	2	22	49	B	no	801	108TA5025	141TA3172	
3	2	22	49	B	no	E254	108TA5012	141TA2987	

2.1

2A

REF [141TA2729](#)

2.1

2A

REF [141TA2959](#)

2.1

2A

REF [141TA2903](#)

2.1

2A

REF [141TA2697](#)

2.1

2A

REF [141TA3172](#)

2.1

2A

REF [141TA2987](#)

If key number is not mentioned, there is no reference on the key or the key switch is supplied with different key numbers.

KEY SWITCHES

For all our latest catalogue updates and company info: www.tvh.com



KEY SWITCHES USED FOR BT

Number of connections	Number of positions	Dia (mm)	Total length (mm)	Type connection	Anti-restart	Key number	TVH-ref of key	REF switch with key	
QTY-CO	QTY-POS	D1	L1	TY-CO	AN-RE	KEY-NR	TVH-KEY		
3	2	22	53	B	no	701	108TA4993	141TA2694	
3	3	16	38	B	no		139TA7572		
3	3	18	65	B	no	14644	108TA5013	141TA2790	
3	3	18	78	B	yes	748	141TA2661	123TA5692	
3	3	18	80	B	yes			128TA5778	
3	3	22	46	B	no			128TA5561	

2.1

2A

REF [141TA2694](#)

3.1

3A

REF [139TA7572](#)

3.3

3A

REF [141TA2790](#)

3.1

3A

REF [123TA5692](#)

3.1

3A

REF [128TA5778](#)

3.2

3D

REF [128TA5561](#)

If key number is not mentioned, there is no reference on the key or the key switch is supplied with different key numbers.



KEY SWITCHES

For all our latest catalogue updates and company info: www.tvh.com

KEY SWITCHES USED FOR BT

Number of connections	Number of positions	Dia (mm)	Total length (mm)	Type connection	Anti-restart	Key number	TVH-ref of key	REF switch with key	
QTY-CO	QTY-POS	D1	L1	TY-CO	AN-RE	KEY-NR	TVH-KEY		
3	3	22	52	B	yes	K11	108TA5017	141TA2706	
3	3	22	52	B	yes			141TA2710	
4	2	19	54	G	no			141TA3045	
4	2	20	54	B	no			110TA8033	
4	2	22	50	B	no	738	110TA3353	141TA2819	
4	2	22	53	B	no	E30	108TA4994	141TA3041	

OFF
ON/ACC
START

3.1

3A

REF [141TA2706](#)

OFF
ON/ACC
START

3.1

3A

REF [141TA2710](#)

OFF
ON

2.1

2C

REF [141TA3045](#)

OFF
ON

2.1

2A

REF [110TA8033](#)

OFF
ON

2.1

2A

REF [141TA2819](#)

OFF
ON

2.1

2A

REF [141TA3041](#)

If key number is not mentioned, there is no reference on the key or the key switch is supplied with different key numbers.

KEY SWITCHES

For all our latest catalogue updates and company info: www.tvh.com



KEY SWITCHES USED FOR BT

Number of connections	Number of positions	Dia (mm)	Total length (mm)	Type connection	Anti-restart	Key number	TVH-ref of key	REF switch with key	
QTY-CO	QTY-POS	D1	L1	TY-CO	AN-RE	KEY-NR	TVH-KEY		
4	2	22	56	B	no			141TA2901	
4	2	22	65	E	no	455	108TA4991	141TA3163	
4	2	30	80	E	no	3095	122TA8983	141TA3146	
4	3	20	63	B	yes			128TA5665	
4	4	18	64	B	no			141TA2929	
4	4	18	66	B	yes	14644	108TA5013	141TA3091	

2.1

2A

REF [141TA2901](#)

2.1

2C

REF [141TA3163](#)

2.1

2A

REF [141TA3146](#)

3.1

3A

REF [128TA5665](#)

4.2

4B

REF [141TA2929](#)

4.7

4A

REF [141TA3091](#)

If key number is not mentioned, there is no reference on the key or the key switch is supplied with different key numbers.



KEY SWITCHES

For all our latest catalogue updates and company info: www.tvh.com

KEY SWITCHES USED FOR BT

Number of connections	Number of positions	Dia (mm)	Total length (mm)	Type connection	Anti-restart	Key number	TVH-ref of key	REF switch with key	
QTY-CO	QTY-POS	D1	L1	TY-CO	AN-RE	KEY-NR	TVH-KEY		
4	4	18	74	B	no	A62597		141TA2952	
4	4	18	81	B	yes		128TA5765	141TA2895	
4	4	25	62	E	yes		110TA3256	141TA2776	
5	2	22	56	B	no			108TA4662	
5	2	22	56	B	no	E41	108TA4995	108TA4763	
5	2	22	56	B	no	E30	108TA4994	108TA4771	

REF [141TA2952](#)

4.1

4B

REF [141TA2895](#)

4.2

4B

REF [141TA2776](#)

4.1

4B

REF [108TA4662](#)

2.1

2A

REF [108TA4763](#)

2.1

2A

REF [108TA4771](#)

2.1

2A

If key number is not mentioned, there is no reference on the key or the key switch is supplied with different key numbers.

KEY SWITCHES

For all our latest catalogue updates and company info: www.tvh.com



KEY SWITCHES USED FOR BT

Number of connections	Number of positions	Dia (mm)	Total length (mm)	Type connection	Anti-restart	Key number	TVH-ref of key	REF switch with key	
QTY-CO	QTY-POS	D1	L1	TY-CO	AN-RE	KEY-NR	TVH-KEY		
5	2	22	56	B	no	K03	108TA4996	108TA4688	
5	3	20	55	B	no	FS880	108TA5024	141TA3049	
5	3	22	62	B	yes	14644	108TA5013	141TA2491	
5	3	25	62	E	yes			141TA2755	
5	4	22	59	E	yes	E30	108TA4994	141TA2703	
5	4	22	59	E	yes			128TA5574	

2.1

2A

REF [108TA4688](#)

3.1

3A

REF [141TA3049](#)

3.1

3A

REF [141TA2491](#)

3.1

3A

REF [141TA2755](#)

4.5

4B

REF [141TA2703](#)

4.5

4B

REF [128TA5574](#)

If key number is not mentioned, there is no reference on the key or the key switch is supplied with different key numbers.



KEY SWITCHES

For all our latest catalogue updates and company info: www.tvh.com

KEY SWITCHES USED FOR BT

Number of connections	Number of positions	Dia (mm)	Total length (mm)	Type connection	Anti-restart	Key number	TVH-ref of key	REF switch with key	
QTY-CO	QTY-POS	D1	L1	TY-CO	AN-RE	KEY-NR	TVH-KEY		
5	4	22	65	E	yes	E30	108TA4994	141TA2719	
5	4	25	64	E	yes			141TA2829	
5	4	28	69	E	no			128TA5642	
6	2	22	77	E	no	KN101	110TA3541	141TA2741	
6	2	24	89	E	no	8R1	129TA4223	141TA2818	
6	3	22	65	B	no	E80	108TA5005	141TA2757	

4.3

4A

REF [141TA2719](#)

4.1

4B

REF [141TA2829](#)

4.2

4B

REF [128TA5642](#)

2.1

2A

REF [141TA2741](#)

2.1

2A

REF [141TA2818](#)

3.1

3A

REF [141TA2757](#)

If key number is not mentioned, there is no reference on the key or the key switch is supplied with different key numbers.

KEY SWITCHES

For all our latest catalogue updates and company info: www.tvh.com



KEY SWITCHES USED FOR BT

Number of connections	Number of positions	Dia (mm)	Total length (mm)	Type connection	Anti-restart	Key number	TVH-ref of key	REF switch with key	
QTY-CO	QTY-POS	D1	L1	TY-CO	AN-RE	KEY-NR	TVH-KEY		
6	3	26	78	BC	no	14603	141TA2654	141TA2690	
6	4	16	65	BC	no	LUCAS	141TA2658	128TA5570	
6	4	20	74	E	no	001	108TA4988	141TA2967	
6	4	22	59	B	yes			128TA5589	
6	4	25	76	E	no			128TA5526	
7	3	25	62	B	yes		129TA3664	141TA2921	

3.1

3A

REF [141TA2690](#)

4.4

4A

REF [128TA5570](#)

4.2

4B

REF [141TA2967](#)

4.5

4B

REF [128TA5589](#)

4.2

4B

REF [128TA5526](#)

3.1

3A

REF [141TA2921](#)

If key number is not mentioned, there is no reference on the key or the key switch is supplied with different key numbers.



KEY SWITCHES

For all our latest catalogue updates and company info: www.tvh.com

KEY SWITCHES USED FOR BT

Number of connections	Number of positions	Dia (mm)	Total length (mm)	Type connection	Anti-restart	Key number	TVH-ref of key	REF switch with key	
QTY-CO	QTY-POS	D1	L1	TY-CO	AN-RE	KEY-NR	TVH-KEY		
7	3	25	54	BD	yes	HYSTER	129TA3559	128TA5724	
7	4	26	78	BC	no	14603	141TA2654	141TA2944	
7	5	32	92	B	yes			141TA2461	
7	5	32	92	B	yes			141TA2469	
9	4	26	82	BC	no	14607	110TA3492	141TA3048	
10	3	22	90	BC	no			116TA5081	

3.1

3A

REF [128TA5724](#)

4.1

4E

REF [141TA2944](#)

5.6

5A

REF [141TA2461](#)

5.6

5A

REF [141TA2469](#)

4.4

4A

REF [141TA3048](#)

3.1

3A

REF [116TA5081](#)

If key number is not mentioned, there is no reference on the key or the key switch is supplied with different key numbers.

KEY SWITCHES

For all our latest catalogue updates and company info: www.tvh.com



KEY SWITCHES USED FOR BT

Number of connections	Number of positions	Dia (mm)	Total length (mm)	Type connection	Anti-restart	Key number	TVH-ref of key	REF switch with key	
QTY-CO	QTY-POS	D1	L1	TY-CO	AN-RE	KEY-NR	TVH-KEY		
10	5	22	65	B	yes	K80	108TA5029	141TA2715	
10	5	26	78	BC	no	14603	141TA2654	128TA5509	

5.3

5F

REF [141TA2715](#)

5.1

5F

REF [128TA5509](#)

If key number is not mentioned, there is no reference on the key or the key switch is supplied with different key numbers.



KEY SWITCHES

For all our latest catalogue updates and company info: www.tvh.com

KEY SWITCHES USED FOR BV ROCLA

Number of connections	Number of positions	Dia (mm)	Total length (mm)	Type connection	Anti-restart	Key number	TVH-ref of key	REF switch with key	
QTY-CO	QTY-POS	D1	L1	TY-CO	AN-RE	KEY-NR	TVH-KEY		
2	2	22	62	E	no	455	108TA4991	108TA4857	
4	2	19	54	B	no	92274	110TA3536	141TA3119	
5	2	22	56	B	no		108TA4667		

2.1

2A

REF [108TA4857](#)

2.1

2A

REF [141TA3119](#)

2.1

2A

REF [108TA4667](#)

If key number is not mentioned, there is no reference on the key or the key switch is supplied with different key numbers.

KEY SWITCHES

For all our latest catalogue updates and company info: www.tvh.com



KEY SWITCHES USED FOR CATERPILLAR

Number of connections	Number of positions	Dia (mm)	Total length (mm)	Type connection	Anti-restart	Key number	TVH-ref of key	REF switch with key	
QTY-CO	QTY-POS	D1	L1	TY-CO	AN-RE	KEY-NR	TVH-KEY		
2	2	15	53	H	no	601	141TA2656	141TA2937	
2	2	16	63	E	no	83357	129TA4185	141TA3082	
2	2	19	51	E	no	NG100	129TA4188	141TA3124	
2	2	19	62	B	no	CH512	118TA5814	141TA2507	
2	2	19	70	E	no	CH751	108TA5000	110TA8189	
2	2	20	69	E	no	PK556	108TA5003	115TA5380	

2.1

2A

REF [141TA2937](#)

2.1

2A

REF [141TA3082](#)

2.1

2A

REF [141TA3124](#)

2.1

2A

REF [141TA2507](#)

2.1

2A

REF [110TA8189](#)

2.1

2A

REF [115TA5380](#)

If key number is not mentioned, there is no reference on the key or the key switch is supplied with different key numbers.



KEY SWITCHES

For all our latest catalogue updates and company info: www.tvh.com

KEY SWITCHES USED FOR CATERPILLAR

Number of connections	Number of positions	Dia (mm)	Total length (mm)	Type connection	Anti-restart	Key number	TVH-ref of key	REF switch with key	
QTY-CO	QTY-POS	D1	L1	TY-CO	AN-RE	KEY-NR	TVH-KEY		
2	2	20	71	E	no	NG100	129TA4188	141TA3128	
2	2	22	62	E	no	455	108TA4991	108TA4852	
2	2	25	65	E	no			141TA2492	
3	2	22	47	B	no	702	106TA2629	141TA3061	
3	2	22	48	B	no	9401	122TA8945	141TA2919	
3	2	22	48	B	no	501	106TA2631	141TA2960	

REF [141TA3128](#)

2.1

2A

REF [108TA4852](#)

2.1

2A

REF [141TA2492](#)

2.1

2A

REF [141TA3061](#)

2.1

2A

REF [141TA2919](#)

2.1

2A

REF [141TA2960](#)

2.1

2A

If key number is not mentioned, there is no reference on the key or the key switch is supplied with different key numbers.

KEY SWITCHES

For all our latest catalogue updates and company info: www.tvh.com



KEY SWITCHES USED FOR CATERPILLAR

Number of connections	Number of positions	Dia (mm)	Total length (mm)	Type connection	Anti-restart	Key number	TVH-ref of key	REF switch with key	
QTY-CO	QTY-POS	D1	L1	TY-CO	AN-RE	KEY-NR	TVH-KEY		
3	2	22	49	B	no			128TA5698	
3	2	22	49	B	no	301	108TA5004	141TA2982	
3	2	22	53	B	no	701	108TA4993	141TA2695	
3	2	22	55	E	no			141TA2900	
3	2	22	69	B	no	606	141TA2665	141TA3149	
3	3	13	51	E	no			128TA5999	

REF [128TA5698](#)

2.1

2A

REF [141TA2982](#)

2.1

2A

REF [141TA2695](#)

2.1

2A

REF [141TA2900](#)

2.1

2A

REF [141TA3149](#)

2.1

2A

REF [128TA5999](#)

3.6

3G

If key number is not mentioned, there is no reference on the key or the key switch is supplied with different key numbers.



KEY SWITCHES

For all our latest catalogue updates and company info: www.tvh.com

KEY SWITCHES USED FOR CATERPILLAR

Number of connections	Number of positions	Dia (mm)	Total length (mm)	Type connection	Anti-restart	Key number	TVH-ref of key	REF switch with key	
QTY-CO	QTY-POS	D1	L1	TY-CO	AN-RE	KEY-NR	TVH-KEY		
3	3	16	59	B	no	83357	129TA4185	110TA8181	
3	3	16	61	E	no	83353	108TA4989	110TA8238	
3	3	16	65	E	no	83357	129TA4185	128TA5775	
3	3	18	65	B	no	14644	108TA5013	108TA4779	
3	3	18	78	B	yes	748	141TA2661	141TA2782	
3	3	20	63	B	no		108TA4928		

REF [110TA8181](#)

3.1

3A

REF [110TA8238](#)

3.1

3A

REF [128TA5775](#)

3.2

3F

REF [108TA4779](#)

3.3

3A

REF [141TA2782](#)

3.1

3A

REF [108TA4928](#)

3.1

3A

If key number is not mentioned, there is no reference on the key or the key switch is supplied with different key numbers.

KEY SWITCHES

For all our latest catalogue updates and company info: www.tvh.com



KEY SWITCHES USED FOR CATERPILLAR

Number of connections	Number of positions	Dia (mm)	Total length (mm)	Type connection	Anti-restart	Key number	TVH-ref of key	REF switch with key		
QTY-CO	QTY-POS	D1	L1	TY-CO	AN-RE	KEY-NR	TVH-KEY			
3	3	20	81	E	no	K11		141TA2795		
3	3	22	52	B	yes			108TA5017		141TA2711
3	3	25	56	E	no					141TA2977
3	3	25	56	E	no	T800A	108TA5006	108TA4842		
3	3	25	56	E	no	T800A	108TA5006	141TA3161		
4	2	19	54	B	no	92274	110TA3536	141TA3120		

3.1

3A

REF [141TA2795](#)

3.1

3A

REF [141TA2711](#)

3.1

3A

REF [141TA2977](#)

3.1

3A

REF [108TA4842](#)

3.1

3A

REF [141TA3161](#)

2.1

2A

REF [141TA3120](#)

If key number is not mentioned, there is no reference on the key or the key switch is supplied with different key numbers.



KEY SWITCHES

For all our latest catalogue updates and company info: www.tvh.com

KEY SWITCHES USED FOR CATERPILLAR

Number of connections	Number of positions	Dia (mm)	Total length (mm)	Type connection	Anti-restart	Key number	TVH-ref of key	REF switch with key	
QTY-CO	QTY-POS	D1	L1	TY-CO	AN-RE	KEY-NR	TVH-KEY		
4	2	22	65	B	no			141TA3134	
4	3	16	60	E	no			141TA2909	
4	3	16	113	E	no			110TA8241	
4	3	20	63	B	no			141TA3174	
4	3	25	69,5	E	yes	D250		129TA4104 110TA7775	
4	3	25	73	E	yes			110TA3258 123TA5694	

2.1

2A

REF [141TA3134](#)

3.1

3G

REF [141TA2909](#)

3.1

3G

REF [110TA8241](#)

3.1

3A

REF [141TA3174](#)

3.1

3A

REF [110TA7775](#)

3.1

3A

REF [123TA5694](#)

If key number is not mentioned, there is no reference on the key or the key switch is supplied with different key numbers.

KEY SWITCHES

For all our latest catalogue updates and company info: www.tvh.com



KEY SWITCHES USED FOR CATERPILLAR

Number of connections	Number of positions	Dia (mm)	Total length (mm)	Type connection	Anti-restart	Key number	TVH-ref of key	REF switch with key	
QTY-CO	QTY-POS	D1	L1	TY-CO	AN-RE	KEY-NR	TVH-KEY		
4	3	25	74	BE	yes			141TA2522	
4	3	25	74	E	yes			141TA2567	
4	4	18	64	B	no			141TA2737	
4	4	18	64	B	no			141TA2930	
4	4	18	66	B	yes	14644	108TA5013	141TA3092	
4	4	18	74	B	no			108TA4700	

REF [141TA2522](#)

3.1

OFF ON/ACC START

3A

REF [141TA2567](#)

3.1

OFF ON/ACC START

3A

REF [141TA2737](#)

type of plug

4.2

GLOW OFF ON/ACC START

4B

REF [141TA2930](#)

4.2

GLOW OFF ON/ACC START

4B

REF [141TA3092](#)

4.7

OFF ACC ON START

4A

REF [108TA4700](#)

4.1

ACC OFF ON/ACC START

4B

If key number is not mentioned, there is no reference on the key or the key switch is supplied with different key numbers.



KEY SWITCHES

For all our latest catalogue updates and company info: www.tvh.com

KEY SWITCHES USED FOR CATERPILLAR

Number of connections	Number of positions	Dia (mm)	Total length (mm)	Type connection	Anti-restart	Key number	TVH-ref of key	REF switch with key	
QTY-CO	QTY-POS	D1	L1	TY-CO	AN-RE	KEY-NR	TVH-KEY		
4	4	18	76	B	yes			141TA3138	
4	4	19	79	H	no			108TA4827	
4	4	25	62	E	yes			110TA3256	
5	2	22	56	B	no			110TA7777	
5	3	25	62	E	yes			108TA4659	
5	4	25	58	F	yes			128TA5503	
								110TA3258	141TA2605



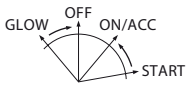

4.2



4I

REF [141TA3138](#)



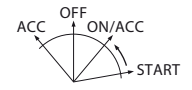

4.1



4B

REF [108TA4827](#)



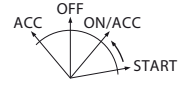

4.1



4B

REF [110TA7777](#)



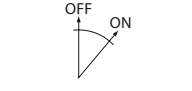

2.1



2A

REF [108TA4659](#)



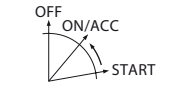

3.1



3A

REF [128TA5503](#)



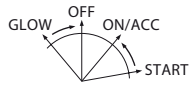

4.2



4B

REF [141TA2605](#)

If key number is not mentioned, there is no reference on the key or the key switch is supplied with different key numbers.

KEY SWITCHES

For all our latest catalogue updates and company info: www.tvh.com



KEY SWITCHES USED FOR CATERPILLAR

Number of connections	Number of positions	Dia (mm)	Total length (mm)	Type connection	Anti-restart	Key number	TVH-ref of key	REF switch with key	
QTY-CO	QTY-POS	D1	L1	TY-CO	AN-RE	KEY-NR	TVH-KEY		
5	4	25	64	E	yes			108TA4570	
6	4	16	65	BC	no	LUCAS	141TA2658	141TA2732	
6	4	20	74	E	no	001	108TA4990	141TA2946	
6	4	20	84	E	no	D3	141TA2664	141TA2557	
6	6	22	104	BH	no	1500	108TA5020	141TA2806	
6	4	25	76	E	no			141TA2939	

4.1

4B

REF [108TA4570](#)

4.4

4A

REF [141TA2732](#)

4.2

4B

REF [141TA2946](#)

4.2

4B

REF [141TA2557](#)

6.1

6B

REF [141TA2806](#)

4.2

4B

REF [141TA2939](#)

If key number is not mentioned, there is no reference on the key or the key switch is supplied with different key numbers.



KEY SWITCHES

For all our latest catalogue updates and company info: www.tvh.com

KEY SWITCHES USED FOR CATERPILLAR

Number of connections	Number of positions	Dia (mm)	Total length (mm)	Type connection	Anti-restart	Key number	TVH-ref of key	REF switch with key	
QTY-CO	QTY-POS	D1	L1	TY-CO	AN-RE	KEY-NR	TVH-KEY		
6	4	25	78	E	no			141TA3152	
6	4	25	79	E	yes	123243	108TA5035	141TA2917	
6	4	28	95	E	no	5154	129TA4124	141TA2753	
7	3	25	62	B	yes		129TA3664	141TA2922	
7	3	25	62	B	yes		141TA2663	141TA2723	
7	3	26	78	BC	yes	14603	141TA2654	141TA3032	

4.2

4B

REF [141TA3152](#)

4.2

4B

REF [141TA2917](#)

4.2

4B

REF [141TA2753](#)

3.1

3A

REF [141TA2922](#)

3.1

3A

REF [141TA2723](#)

3.1

3A

REF [141TA3032](#)

If key number is not mentioned, there is no reference on the key or the key switch is supplied with different key numbers.

KEY SWITCHES

For all our latest catalogue updates and company info: www.tvh.com



KEY SWITCHES USED FOR CATERPILLAR

Number of connections	Number of positions	Dia (mm)	Total length (mm)	Type connection	Anti-restart	Key number	TVH-ref of key	REF switch with key	
QTY-CO	QTY-POS	D1	L1	TY-CO	AN-RE	KEY-NR	TVH-KEY		
10	3	22	90	BC	yes			<u>141TA2840</u>	
10	5	26	78	BC	yes	14607	<u>110TA3492</u>	<u>141TA3076</u>	
10	5	26	78	BC	no	14603	<u>141TA2654</u>	<u>141TA2846</u>	

3.1

3A

REF 141TA2840

5.1

5F

REF 141TA3076

5.6

5F

REF 141TA2846

If key number is not mentioned, there is no reference on the key or the key switch is supplied with different key numbers.



KEY SWITCHES

For all our latest catalogue updates and company info: www.tvh.com

KEY SWITCHES USED FOR CESAB

Number of connections	Number of positions	Dia (mm)	Total length (mm)	Type connection	Anti-restart	Key number	TVH-ref of key	REF switch with key	
QTY-CO	QTY-POS	D1	L1	TY-CO	AN-RE	KEY-NR	TVH-KEY		
2	2	22	53	B	no	002	129TA3940	141TA3089	
3	2	19	40	G	no			141TA2835	
3	2	22	44	B	no			110TA8113	
3	3	22	52	B	yes	E30	141TA2707		
4	2	22	53	B	no		108TA4994	141TA3042	
4	2	22	56	B	no			128TA5926	

REF [141TA3089](#)

2.1

2A

REF [141TA2835](#)

2.1

2A

REF [110TA8113](#)

2.1

2A

REF [141TA2707](#)

3.1

3A

REF [141TA3042](#)

2.1

2A

REF [128TA5926](#)

2.1

2A

If key number is not mentioned, there is no reference on the key or the key switch is supplied with different key numbers.

KEY SWITCHES

For all our latest catalogue updates and company info: www.tvh.com



KEY SWITCHES USED FOR CESAB

Number of connections	Number of positions	Dia (mm)	Total length (mm)	Type connection	Anti-restart	Key number	TVH-ref of key	REF switch with key	
QTY-CO	QTY-POS	D1	L1	TY-CO	AN-RE	KEY-NR	TVH-KEY		
4	2	22	65	E	no	455	108TA4991	141TA3164	
4	3	22	49	B	yes			108TA4959	
4	4	18	66	B	yes	14644	108TA5013	141TA3093	
5	2	22	56	B	no	K03	108TA4996	141TA2885	
7	4	19	72	BC	no	FS880	108TA5024	141TA2592	
10	3	22	90	BC	no			116TA7794	

REF [141TA3164](#)

2.1

2C

REF [108TA4959](#)

3.1

3A

REF [141TA3093](#)

4.7

4A

REF [141TA2885](#)

2.1

2A

REF [141TA2592](#)

4.4

4A

REF [116TA7794](#)

3.1

3A

If key number is not mentioned, there is no reference on the key or the key switch is supplied with different key numbers.



KEY SWITCHES

For all our latest catalogue updates and company info: www.tvh.com

KEY SWITCHES USED FOR CLARK

Number of connections	Number of positions	Dia (mm)	Total length (mm)	Type connection	Anti-restart	Key number	TVH-ref of key	REF switch with key	
QTY-CO	QTY-POS	D1	L1	TY-CO	AN-RE	KEY-NR	TVH-KEY		
2	2	15	53	H	no	684	108TA4988	110TA7445	
2	2	16	63	E	no	83357	129TA4185	141TA3083	
2	2	19	49	E	no			141TA2588	
2	2	19	52	G	no	9471	141TA2657	141TA2863	
2	2	19	62	B	no	CH512	118TA5814	108TA4788	
2	2	19	64	H	no	CH512	110TA3503	108TA4809	

REF [110TA7445](#)

2.1

2A

REF [141TA3083](#)
With NO-contact

2.1

2A

REF [141TA2588](#)

2.1

2A

REF [141TA2863](#)

2.1

2C

REF [108TA4788](#)

2.1

2A

REF [108TA4809](#)

2.1

2A

If key number is not mentioned, there is no reference on the key or the key switch is supplied with different key numbers.

KEY SWITCHES

For all our latest catalogue updates and company info: www.tvh.com



KEY SWITCHES USED FOR CLARK

Number of connections	Number of positions	Dia (mm)	Total length (mm)	Type connection	Anti-restart	Key number	TVH-ref of key	REF switch with key	
QTY-CO	QTY-POS	D1	L1	TY-CO	AN-RE	KEY-NR	TVH-KEY		
2	2	20	59	E	no	CH501	122TA8962	128TA5812	
2	2	22	67	E	no	KN101	110TA3541	108TA4765	
2	2	24	44	G	no			141TA2497	
2	2	25	61	E	no	701 TCM	128TA5735	141TA2856	
2	3	19	45	E	no	2007	141TA2667	141TA2531	
2	3	25	55	E	no			141TA2800	

2.1

2A

REF [128TA5812](#)

2.1

2A

REF [108TA4765](#)

2.1

2A

REF [141TA2497](#)

2.1

2A

REF [141TA2856](#)

3.3

3A

REF [141TA2531](#)

3.1

3A

REF [141TA2800](#)

If key number is not mentioned, there is no reference on the key or the key switch is supplied with different key numbers.



KEY SWITCHES

For all our latest catalogue updates and company info: www.tvh.com

KEY SWITCHES USED FOR CLARK

Number of connections	Number of positions	Dia (mm)	Total length (mm)	Type connection	Anti-restart	Key number	TVH-ref of key	REF switch with key	
QTY-CO	QTY-POS	D1	L1	TY-CO	AN-RE	KEY-NR	TVH-KEY		
3	2	19	42	G	no			141TA3166	
3	2	22	44	B	no			141TA3115	
3	2	22	48	B	no	530	106TA2637	128TA5543	
3	2	22	48	B	no	502	106TA2633	106TA2632	
3	2	22	49	E	no			141TA2551	
3	2	25	67	H	no	777KOREA	128TA5923	128TA5818	

2.1

2A

REF [141TA3166](#)

2.1

2A

REF [141TA3115](#)

2.1

2A

REF [128TA5543](#)

2.1

2A

REF [106TA2632](#)

2.1

2A

REF [141TA2551](#)

2.1

2A

REF [128TA5818](#)

If key number is not mentioned, there is no reference on the key or the key switch is supplied with different key numbers.

KEY SWITCHES

For all our latest catalogue updates and company info: www.tvh.com



KEY SWITCHES USED FOR CLARK

Number of connections	Number of positions	Dia (mm)	Total length (mm)	Type connection	Anti-restart	Key number	TVH-ref of key	REF switch with key	
QTY-CO	QTY-POS	D1	L1	TY-CO	AN-RE	KEY-NR	TVH-KEY		
3	2	25	67	H	no	777KOREA	128TA5923	141TA2583	
3	3	16	61	E	no	83353	108TA4989	141TA3031	
3	3	16	65	E	no	83357	129TA4185	141TA2872	
3	3	18	78	B	yes	748	141TA2661	141TA2783	
3	3	19	84	H	no			128TA5773	
3	3	20	63	B	no			141TA3012	

2.1

2A

REF [141TA2583](#)

3.1

3A

REF [141TA3031](#)

3.2

3F

REF [141TA2872](#)

3.1

3A

REF [141TA2783](#)

3.2

3B

REF [128TA5773](#)

3.1

3A

REF [141TA3012](#)

If key number is not mentioned, there is no reference on the key or the key switch is supplied with different key numbers.



KEY SWITCHES

For all our latest catalogue updates and company info: www.tvh.com

KEY SWITCHES USED FOR CLARK

Number of connections	Number of positions	Dia (mm)	Total length (mm)	Type connection	Anti-restart	Key number	TVH-ref of key	REF switch with key	
QTY-CO	QTY-POS	D1	L1	TY-CO	AN-RE	KEY-NR	TVH-KEY		
3	3	20	81	E	no	E30 BOSCH E11		141TA2796	
3	3	22	52	B	yes			108TA4634	
3	3	22	52	B	yes			115TA5362	
3	3	22	52	B	yes			141TA2825	
3	3	22	60	E	no			141TA2749	
3	3	25	56	E	no			118TA5750	

3.1

3A

REF [141TA2796](#)

3.1

3A

REF [108TA4634](#)

3.1

3A

REF [115TA5362](#)

3.1

3A

REF [141TA2825](#)

3.1

3A

REF [141TA2749](#)

3.1

3A

REF [118TA5750](#)

If key number is not mentioned, there is no reference on the key or the key switch is supplied with different key numbers.

KEY SWITCHES

For all our latest catalogue updates and company info: www.tvh.com



KEY SWITCHES USED FOR CLARK

Number of connections	Number of positions	Dia (mm)	Total length (mm)	Type connection	Anti-restart	Key number	TVH-ref of key	REF switch with key	
QTY-CO	QTY-POS	D1	L1	TY-CO	AN-RE	KEY-NR	TVH-KEY		
3	3	34	85	G	yes	E30 701 TCM	108TA4994 128TA5735	108TA4983	
4	2	19	54	G	no			141TA3046	
4	2	22	53	B	no			141TA3043	
4	2	25	61	E	no			141TA2858	
4	3	16	60	E	no			110TA7852	
4	3	20	63	B	no			141TA3175	

3.1

3A

REF [108TA4983](#)

2.1

2C

REF [141TA3046](#)

2.1

2A

REF [141TA3043](#)

2.1

2A

REF [141TA2858](#)

3.1

3G

REF [110TA7852](#)

3.1

3A

REF [141TA3175](#)

If key number is not mentioned, there is no reference on the key or the key switch is supplied with different key numbers.



KEY SWITCHES

For all our latest catalogue updates and company info: www.tvh.com

KEY SWITCHES USED FOR CLARK

Number of connections	Number of positions	Dia (mm)	Total length (mm)	Type connection	Anti-restart	Key number	TVH-ref of key	REF switch with key	
QTY-CO	QTY-POS	D1	L1	TY-CO	AN-RE	KEY-NR	TVH-KEY		
4	3	25	64	E	yes	777KOREA	128TA5923	141TA2477	
4	3	25	68	E	yes	777EXPORT	115TA5483	128TA5802	
4	3	25	68	E	yes			141TA2566	
4	3	25	70	E	yes			141TA2525	
4	3	25	71	E	yes	777KOREA	128TA5923	141TA2529	
4	4	18	64	B	no			141TA2931	

3.1

3A

REF [141TA2477](#)

type of plug

3.1

3A

REF [128TA5802](#)

3.1

3A

REF [141TA2566](#)

3.1

3A

REF [141TA2525](#)

3.1

3A

REF [141TA2529](#)

type of plug

4.2

4B

REF [141TA2931](#)

If key number is not mentioned, there is no reference on the key or the key switch is supplied with different key numbers.

KEY SWITCHES

For all our latest catalogue updates and company info: www.tvh.com



KEY SWITCHES USED FOR CLARK

Number of connections	Number of positions	Dia (mm)	Total length (mm)	Type connection	Anti-restart	Key number	TVH-ref of key	REF switch with key	
QTY-CO	QTY-POS	D1	L1	TY-CO	AN-RE	KEY-NR	TVH-KEY		
4	4	18	74	B	no			141TA2953	
4	4	18	76	B	yes			141TA3139	
4	4	19	63	E	no			108TA4893	
4	4	19	70	H	yes			141TA3069	
4	4	19	79	H	no			141TA2808	
4	4	25	62	E	yes		110TA3256	141TA2777	

REF [141TA2953](#)

4.1

4B

REF [141TA3139](#)

4.2

4I

REF [108TA4893](#)

4.2

4H

REF [141TA3069](#)

4.1

4I

REF [141TA2808](#)

4.1

4B

REF [141TA2777](#)

4.1

4B

If key number is not mentioned, there is no reference on the key or the key switch is supplied with different key numbers.



KEY SWITCHES

For all our latest catalogue updates and company info: www.tvh.com

KEY SWITCHES USED FOR CLARK

Number of connections	Number of positions	Dia (mm)	Total length (mm)	Type connection	Anti-restart	Key number	TVH-ref of key	REF switch with key	
QTY-CO	QTY-POS	D1	L1	TY-CO	AN-RE	KEY-NR	TVH-KEY		
4	4	26	58	E	no	83357	129TA4184	141TA2570	
4	4	26	80	H	no			141TA2521	
5	2	22	56	B	no			108TA4658	
5	3	25	62	E	yes			110TA8272	
5	3	25	70	E	no			128TA5816	
5	3	25	75	E	no			141TA2533	

4.1

4B

REF [141TA2570](#)

4.2

4B

REF [141TA2521](#)

2.1

2A

REF [108TA4658](#)

3.1

3A

REF [110TA8272](#)

3.1

3A

REF [128TA5816](#)

3.1

3A

REF [141TA2533](#)

If key number is not mentioned, there is no reference on the key or the key switch is supplied with different key numbers.

KEY SWITCHES

For all our latest catalogue updates and company info: www.tvh.com



KEY SWITCHES USED FOR CLARK

Number of connections	Number of positions	Dia (mm)	Total length (mm)	Type connection	Anti-restart	Key number	TVH-ref of key	REF switch with key	
QTY-CO	QTY-POS	D1	L1	TY-CO	AN-RE	KEY-NR	TVH-KEY		
5	4	22	59	E	yes	E30	108TA4994	108TA4726	
5	4	22	65	E	yes	E30	108TA4994	110TA7657	
5	4	25	64	E	yes			110TA7469	
5	4	28	81	E	no			141TA2511	
6	2	22	77	E	no	KN101	110TA3541	108TA4811	
6	3	14	48	B	no		110TA3504	141TA2523	

4.5

4B

REF [108TA4726](#)

4.3

4A

REF [110TA7657](#)

4.1

4B

REF [110TA7469](#)

4.2

4B

REF [141TA2511](#)

2.1

2A

REF [108TA4811](#)

3.1

3A

REF [141TA2523](#)

If key number is not mentioned, there is no reference on the key or the key switch is supplied with different key numbers.



KEY SWITCHES

For all our latest catalogue updates and company info: www.tvh.com

KEY SWITCHES USED FOR CLARK

Number of connections	Number of positions	Dia (mm)	Total length (mm)	Type connection	Anti-restart	Key number	TVH-ref of key	REF switch with key	
QTY-CO	QTY-POS	D1	L1	TY-CO	AN-RE	KEY-NR	TVH-KEY		
6	3	22	65	B	no	E80	108TA5005	106TA2650	
6	3	25	55	D	yes	HYSTER	129TA3559	128TA5534	
6	4	16	65	BC	no	LUCAS	141TA2658	141TA2733	
6	4	19	96	E	no			141TA2850	
6	4	20	74	E	no	001	108TA4990	141TA2947	
6	4	20	74	E	no	001	108TA4990	141TA2968	

3.1

3A

REF [106TA2650](#)

3.1

3A

REF [128TA5534](#)

4.4

4A

REF [141TA2733](#)

4.2

4B

REF [141TA2850](#)

4.2

4B

REF [141TA2947](#)

4.2

4B

REF [141TA2968](#)

If key number is not mentioned, there is no reference on the key or the key switch is supplied with different key numbers.

KEY SWITCHES

For all our latest catalogue updates and company info: www.tvh.com



KEY SWITCHES USED FOR CLARK

Number of connections	Number of positions	Dia (mm)	Total length (mm)	Type connection	Anti-restart	Key number	TVH-ref of key	REF switch with key	
QTY-CO	QTY-POS	D1	L1	TY-CO	AN-RE	KEY-NR	TVH-KEY		
6	4	20	74	E	no	001	108TA4990	141TA2989	
6	4	20	85	E	no	777EXPORT	141TA2745		
6	4	20	86	E	no		115TA5483	128TA5695	
6	4	20	86	E	no		115TA5385		
6	4	22	59	B	yes	K30	128TA5590		
6	4	25	76	E	no		108TA5014	141TA2940	

REF [141TA2989](#)

4.2

GLOW OFF ON/ACC START

4B

REF [141TA2745](#)

4.2

GLOW OFF ON/ACC START

4B

REF [128TA5695](#)

4.2

GLOW OFF ON/ACC START

4B

REF [115TA5385](#)

4.2

GLOW OFF ON/ACC START

4B

REF [128TA5590](#)

4.5

ACC OFF ON/ACC START PUSH AND TURN

4B

REF [141TA2940](#)

4.2

GLOW OFF ON/ACC START

4B

If key number is not mentioned, there is no reference on the key or the key switch is supplied with different key numbers.



KEY SWITCHES

For all our latest catalogue updates and company info: www.tvh.com

KEY SWITCHES USED FOR CLARK

Number of connections	Number of positions	Dia (mm)	Total length (mm)	Type connection	Anti-restart	Key number	TVH-ref of key	REF switch with key		
QTY-CO	QTY-POS	D1	L1	TY-CO	AN-RE	KEY-NR	TVH-KEY			
6	4	25	78	E	no	1500		141TA3153		
6	5	32	83	B	no			116TA5597		
6	6	22	104	BH	no			108TA5020		141TA2807
7	3	25	62	B	yes			129TA3664		110TA7527
7	3	25	62	B	yes			141TA2663		141TA2724
7	4	26	78	BC	no	14603	141TA2654	108TA4681		

4.2

4B

REF [141TA3153](#)

5.2

5B

REF [116TA5597](#)

6.1

6B

REF [141TA2807](#)

3.1

3A

REF [110TA7527](#)

3.1

3A

REF [141TA2724](#)

4.1

4E

REF [108TA4681](#)

If key number is not mentioned, there is no reference on the key or the key switch is supplied with different key numbers.

KEY SWITCHES

For all our latest catalogue updates and company info: www.tvh.com



KEY SWITCHES USED FOR CLARK

Number of connections	Number of positions	Dia (mm)	Total length (mm)	Type connection	Anti-restart	Key number	TVH-ref of key	REF switch with key	
QTY-CO	QTY-POS	D1	L1	TY-CO	AN-RE	KEY-NR	TVH-KEY		
7	4	26	78	BC	yes	14610	115TA5400	115TA5389	
10	5	26	78	BC	no	14603	141TA2654	110TA7623	

4.1

4B

REF [115TA5389](#)

5.1

5F

REF [110TA7623](#)

If key number is not mentioned, there is no reference on the key or the key switch is supplied with different key numbers.



KEY SWITCHES

For all our latest catalogue updates and company info: www.tvh.com

KEY SWITCHES USED FOR CLIMAX

Number of connections	Number of positions	Dia (mm)	Total length (mm)	Type connection	Anti-restart	Key number	TVH-ref of key	REF switch with key	
QTY-CO	QTY-POS	D1	L1	TY-CO	AN-RE	KEY-NR	TVH-KEY		
2	2	24	40	G	no	5541	141TA2668	110TA8122	
3	3	20	81	E	no	T800A	108TA4795	108TA4795	
3	3	25	56	E	no		108TA4837	108TA4837	
3	3	25	56	E	no		108TA5006	110TA8121	
4	2	19	37	G	no	TOK3	141TA2914	141TA2914	
4	2	19	42	A	no		128TA5645	115TA5377	

2.1

2A

REF [110TA8122](#)

3.1

3A

REF [108TA4795](#)

3.1

3A

REF [108TA4837](#)

3.1

3A

REF [110TA8121](#)

2.1

2A

REF [141TA2914](#)

2.1

2A

REF [115TA5377](#)

If key number is not mentioned, there is no reference on the key or the key switch is supplied with different key numbers.

KEY SWITCHES

For all our latest catalogue updates and company info: www.tvh.com



KEY SWITCHES USED FOR CLIMAX

Number of connections	Number of positions	Dia (mm)	Total length (mm)	Type connection	Anti-restart	Key number	TVH-ref of key	REF switch with key	
QTY-CO	QTY-POS	D1	L1	TY-CO	AN-RE	KEY-NR	TVH-KEY		
4	4	19	79	H	no			108TA4829	
5	3	20	55	B	no	FS880	108TA5024	141TA3050	
6	3	16	62	B	no	LUCAS	141TA2658	128TA5854	
6	4	16	65	BC	no	LUCAS	141TA2658	141TA2735	
6	4	19	96	E	no			108TA4558	
6	4	20	82	E	no			108TA5015	

4.1

4B

REF [108TA4829](#)

3.1

3A

REF [141TA3050](#)

3.1

3A

REF [128TA5854](#)

4.4

4A

REF [141TA2735](#)

4.2

4B

REF [108TA4558](#)

4.2

4B

REF [116TA5594](#)

If key number is not mentioned, there is no reference on the key or the key switch is supplied with different key numbers.



KEY SWITCHES

For all our latest catalogue updates and company info: www.tvh.com

KEY SWITCHES USED FOR CLIMAX

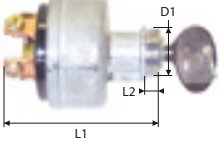
Number of connections	Number of positions	Dia (mm)	Total length (mm)	Type connection	Anti-restart	Key number	TVH-ref of key	REF switch with key	
QTY-CO	QTY-POS	D1	L1	TY-CO	AN-RE	KEY-NR	TVH-KEY		
8	2	19	50	A	no	001	129TA4200	141TA2467	



OFF
ON

2.1



2A

REF [141TA2467](#)

If key number is not mentioned, there is no reference on the key or the key switch is supplied with different key numbers.

KEY SWITCHES

For all our latest catalogue updates and company info: www.tvh.com



KEY SWITCHES USED FOR CROWN

Number of connections	Number of positions	Dia (mm)	Total length (mm)	Type connection	Anti-restart	Key number	TVH-ref of key	REF switch with key		
QTY-CO	QTY-POS	D1	L1	TY-CO	AN-RE	KEY-NR	TVH-KEY			
2	2	19	70	E	no	CH751	108TA5000	108TA4909		
2	2	20	51	E	no			128TA5745		
2	2	21	44	B	no			128TA5785		
2	2	24	45	B	no			141TA2549		
3	3	25	47	F	yes			110TA3255		141TA2867
3	3	25	49	G	yes					141TA2548

REF [108TA4909](#)

2.1

2A

REF [128TA5745](#)

2.1

2A

REF [128TA5785](#)

2.1

2A

REF [141TA2549](#)

2.1

2A

REF [141TA2867](#)

3.1

3A

type of plug

REF [141TA2548](#)

3.1

3A

type of plug

If key number is not mentioned, there is no reference on the key or the key switch is supplied with different key numbers.



KEY SWITCHES

For all our latest catalogue updates and company info: www.tvh.com

KEY SWITCHES USED FOR CROWN

Number of connections	Number of positions	Dia (mm)	Total length (mm)	Type connection	Anti-restart	Key number	TVH-ref of key	REF switch with key	
QTY-CO	QTY-POS	D1	L1	TY-CO	AN-RE	KEY-NR	TVH-KEY		
3	3	22	52	B	yes	003	128TA5645 129TA3447 128TA5737	128TA5520 128TA5763	
3	3	25	52	F	yes			115TA5376 141TA2524 141TA2518 141TA3070	
4	2	19	42	A	no				
4	3	25	47	F	yes				
4	3	25	64	E	yes				
4	4	19	70	H	yes				

3.1

3A

REF [128TA5520](#)

3.1

3A

REF [128TA5763](#)

2.1

2A

REF [115TA5376](#)

3.1

3A

REF [141TA2524](#)

3.1

3A

REF [141TA2518](#)

4.1

4I

REF [141TA3070](#)

If key number is not mentioned, there is no reference on the key or the key switch is supplied with different key numbers.

KEY SWITCHES



For all our latest catalogue updates and company info: www.tvh.com

KEY SWITCHES USED FOR CROWN

Number of connections	Number of positions	Dia (mm)	Total length (mm)	Type connection	Anti-restart	Key number	TVH-ref of key	REF switch with key	
QTY-CO	QTY-POS	D1	L1	TY-CO	AN-RE	KEY-NR	TVH-KEY		
5	4	25	64	E	yes			110TA7460	
7	3	25	62	B	yes		141TA2663	141TA2725	

4.1

REF [110TA7460](#)

4B

3.1

REF [141TA2725](#)

3A

If key number is not mentioned, there is no reference on the key or the key switch is supplied with different key numbers.



KEY SWITCHES

For all our latest catalogue updates and company info: www.tvh.com

KEY SWITCHES USED FOR DESTA

Number of connections	Number of positions	Dia (mm)	Total length (mm)	Type connection	Anti-restart	Key number	TVH-ref of key	REF switch with key	
QTY-CO	QTY-POS	D1	L1	TY-CO	AN-RE	KEY-NR	TVH-KEY		
3	3	22	53	E	No			<u>108TA4890</u>	
3	3	22	66	B	No	14644	<u>108TA5013</u> <u>110TA8618</u>		

3.1

3A

REF 108TA4890

3.3

3A

REF 110TA8618

If key number is not mentioned, there is no reference on the key or the key switch is supplied with different key numbers.

KEY SWITCHES

For all our latest catalogue updates and company info: www.tvh.com

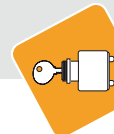

KEY SWITCHES USED FOR FABA

Number of connections	Number of positions	Dia (mm)	Total length (mm)	Type connection	Anti-restart	Key number	TVH-ref of key	REF switch with key	
QTY-CO	QTY-POS	D1	L1	TY-CO	AN-RE	KEY-NR	TVH-KEY		
3	2	22	49	B	no	503	106TA2635	128TA5518	
4	2	16	49	G	no	1D21	129TA3475	108TA4950	

REF [128TA5518](#)

2.1

2A

REF [108TA4950](#)

2.1

2A

type of plug

If key number is not mentioned, there is no reference on the key or the key switch is supplied with different key numbers.



KEY SWITCHES

For all our latest catalogue updates and company info: www.tvh.com

KEY SWITCHES USED FOR FANTUZZI

Number of connections	Number of positions	Dia (mm)	Total length (mm)	Type connection	Anti-restart	Key number	TVH-ref of key	REF switch with key	
QTY-CO	QTY-POS	D1	L1	TY-CO	AN-RE	KEY-NR	TVH-KEY		
2	2	22	72	E	no	455	108TA4991	141TA2603	
5	4	22	65	E	yes	E30	108TA4994	128TA5711	
7	4	16	65	BC	no	LUCAS	141TA2658	141TA2973	
7	4	22	56	B	no	E30	108TA4994	128TA5625	
7	4	26	51	BE	no		129TA3543	141TA2702	
8	4	22	64	BC	yes		108TA5008	141TA2439	

2.2

2A

REF [141TA2603](#)

4.3

4A

REF [128TA5711](#)

4.4

4A

REF [141TA2973](#)

4.2

4B

REF [128TA5625](#)

4.6

4G

REF [141TA2702](#)

4.3

4A

REF [141TA2439](#)

If key number is not mentioned, there is no reference on the key or the key switch is supplied with different key numbers.

KEY SWITCHES

For all our latest catalogue updates and company info: www.tvh.com



KEY SWITCHES USED FOR FANTUZZI

Number of connections	Number of positions	Dia (mm)	Total length (mm)	Type connection	Anti-restart	Key number	TVH-ref of key	REF switch with key	
QTY-CO	QTY-POS	D1	L1	TY-CO	AN-RE	KEY-NR	TVH-KEY		
8	4	22	66	BC	no			<u>108TA4976</u>	
10	5	26	78	BC	no	14603	<u>141TA2654</u>	<u>141TA2927</u>	
10	5	26	78	BC	yes	14603	<u>141TA2654</u>	<u>128TA5689</u>	

REF 108TA4976

4.3

4A

REF 141TA2927

5.1

5F

REF 128TA5689

5.6

5F

If key number is not mentioned, there is no reference on the key or the key switch is supplied with different key numbers.



KEY SWITCHES

For all our latest catalogue updates and company info: www.tvh.com

KEY SWITCHES USED FOR FENWICK - PEG

Number of connections	Number of positions	Dia (mm)	Total length (mm)	Type connection	Anti-restart	Key number	TVH-ref of key	REF switch with key	
QTY-CO	QTY-POS	D1	L1	TY-CO	AN-RE	KEY-NR	TVH-KEY		
2	2	15	53	H	no	601	141TA2656	110TA7643	
2	2	15	53	H	no	684	108TA4988	141TA2942	
2	2	16	48	B	no	633	108TA5011	108TA4580	
2	2	16	48	B	no	695	108TA5010	108TA4656	
3	2	22	49	B	no	503	106TA2635	108TA4630	
3	2	22	49	B	no	801	108TA5025	128TA5614	

2.1

2A

REF [110TA7643](#)

2.1

2A

REF [141TA2942](#)

2.1

2A

REF [108TA4580](#)

2.1

2A

REF [108TA4656](#)

2.1

2A

REF [108TA4630](#)

2.1

2A

REF [128TA5614](#)

If key number is not mentioned, there is no reference on the key or the key switch is supplied with different key numbers.

KEY SWITCHES

For all our latest catalogue updates and company info: www.tvh.com



KEY SWITCHES USED FOR FENWICK - PEG

Number of connections	Number of positions	Dia (mm)	Total length (mm)	Type connection	Anti-restart	Key number	TVH-ref of key	REF switch with key	
QTY-CO	QTY-POS	D1	L1	TY-CO	AN-RE	KEY-NR	TVH-KEY		
3	2	22	49	B	no	E254	108TA5012	108TA4871	
3	2	22	49	B	no	802	108TA5030	128TA5656	
3	3	18	65	B	no	14644	108TA5013	108TA4781	
4	2	16	49	G	no	1D21	129TA3475	141TA2457	
4	5	34	74	E	no			108TA4862	
5	3	18	66	B	yes	14644	108TA5013	110TA8226	

2.1

2A

REF [108TA4871](#)

2.1

2A

REF [128TA5656](#)

3.3

3A

REF [108TA4781](#)

2.1

2A

REF [141TA2457](#)

5.4

5A

REF [108TA4862](#)

3.1

3A

REF [110TA8226](#)

If key number is not mentioned, there is no reference on the key or the key switch is supplied with different key numbers.



KEY SWITCHES

For all our latest catalogue updates and company info: www.tvh.com

KEY SWITCHES USED FOR FENWICK - PEG

Number of connections	Number of positions	Dia (mm)	Total length (mm)	Type connection	Anti-restart	Key number	TVH-ref of key	REF switch with key	
QTY-CO	QTY-POS	D1	L1	TY-CO	AN-RE	KEY-NR	TVH-KEY		
5	4	19	55	B	no			141TA2442	
5	4	22	59	E	yes	E30	108TA4994	108TA4729	
5	4	22	59	E	yes			108TA4753	
5	4	22	65	E	yes	E30	108TA4994	110TA7665	
6	3	26	78	BC	no	14603	141TA2654	128TA5531	
9	4	26	78	BC	yes	14603	141TA2654	128TA5508	

4.1

4B

REF [141TA2442](#)

4.5

4B

REF [108TA4729](#)

4.5

4B

REF [108TA4753](#)

4.3

4A

REF [110TA7665](#)

3.1

3A

REF [128TA5531](#)

4.4

4A

REF [128TA5508](#)

If key number is not mentioned, there is no reference on the key or the key switch is supplied with different key numbers.

KEY SWITCHES

For all our latest catalogue updates and company info: www.tvh.com



KEY SWITCHES USED FOR FENWICK - PEG

Number of connections	Number of positions	Dia (mm)	Total length (mm)	Type connection	Anti-restart	Key number	TVH-ref of key	REF switch with key	
QTY-CO	QTY-POS	D1	L1	TY-CO	AN-RE	KEY-NR	TVH-KEY		
10	5	26	78	BC	yes	14603	141TA2654	128TA5688	
10	5	26	78	BC	no	14603	141TA2654	128TA5626	
16	3	30	126	E	no	455	108TA4991	116TA7795	

5.6

5F

REF [128TA5688](#)

5.6

5F

REF [128TA5626](#)

3.2

3B

REF [116TA7795](#)

If key number is not mentioned, there is no reference on the key or the key switch is supplied with different key numbers.



KEY SWITCHES

For all our latest catalogue updates and company info: www.tvh.com

KEY SWITCHES USED FOR FIAT - OM PIMESPO

Number of connections	Number of positions	Dia (mm)	Total length (mm)	Type connection	Anti-restart	Key number	TVH-ref of key	REF switch with key	
QTY-CO	QTY-POS	D1	L1	TY-CO	AN-RE	KEY-NR	TVH-KEY		
2	2	19	52	G	no	9471	141TA2657	141TA2864	
2	2	22	50	B	no			115TA5392	
3	2	22	38	B	no			110TA7888	
3	2	22	44	B	no			110TA8615	
3	2	22	48	B	no	530	106TA2637	123TA5700	
3	2	22	49	B	no	801	108TA5025	141TA3168	

2.1

2C

REF [141TA2864](#)

2.1

2A

REF [115TA5392](#)

2.1

2A

REF [110TA7888](#)

2.1

2A

REF [110TA8615](#)

2.1

2A

REF [123TA5700](#)

2.1

2A

REF [141TA3168](#)

If key number is not mentioned, there is no reference on the key or the key switch is supplied with different key numbers.

KEY SWITCHES

For all our latest catalogue updates and company info: www.tvh.com



KEY SWITCHES USED FOR FIAT - OM PIMESPO

Number of connections	Number of positions	Dia (mm)	Total length (mm)	Type connection	Anti-restart	Key number	TVH-ref of key	REF switch with key	
QTY-CO	QTY-POS	D1	L1	TY-CO	AN-RE	KEY-NR	TVH-KEY		
3	2	22	49	B	no	802	108TA5030	141TA3018	
3	3	22	46	B	no			110TA7851	
3	3	22	52	B	yes			108TA4637	
3	3	22	53	B	no			115TA5382	
4	2	16	37	G	no	311	141TA2669	109TA5978	
4	2	22	53	B	no	E30	108TA4994	141TA3044	

2.1

2A

REF [141TA3018](#)

3.2

3D

REF [110TA7851](#)

3.1

3A

REF [108TA4637](#)

3.2

3D

REF [115TA5382](#)

2.1

2A

REF [109TA5978](#)

2.1

2A

REF [141TA3044](#)

If key number is not mentioned, there is no reference on the key or the key switch is supplied with different key numbers.





KEY SWITCHES

For all our latest catalogue updates and company info: www.tvh.com

KEY SWITCHES USED FOR FIAT - OM PIMESPO

Number of connections	Number of positions	Dia (mm)	Total length (mm)	Type connection	Anti-restart	Key number	TVH-ref of key	REF switch with key	
QTY-CO	QTY-POS	D1	L1	TY-CO	AN-RE	KEY-NR	TVH-KEY		
4	2	30	82	E	no	3095	129TA4021	108TA4899	
5	2	22	56	B	no			108TA4661	
5	3	20	55	B	no	FS880	108TA5024	115TA5366	
5	4	22	59	E	yes	E30	108TA4994	108TA4730	
5	4	22	65	E	yes	E30	108TA4994	108TA4621	
6	3	20	71	B	yes	U7800	128TA5782	141TA2882	







2.1



2C

REF [108TA4899](#)







2.1



2A

REF [108TA4661](#)





3.1



3A

REF [115TA5366](#)



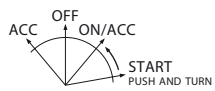

4.5



4B

REF [108TA4730](#)



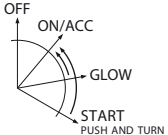



4.3



4A

REF [108TA4621](#)





3.1



3A

REF [141TA2882](#)

If key number is not mentioned, there is no reference on the key or the key switch is supplied with different key numbers.

KEY SWITCHES

For all our latest catalogue updates and company info: www.tvh.com



KEY SWITCHES USED FOR FIAT - OM PIMESPO

Number of connections	Number of positions	Dia (mm)	Total length (mm)	Type connection	Anti-restart	Key number	TVH-ref of key	REF switch with key	
QTY-CO	QTY-POS	D1	L1	TY-CO	AN-RE	KEY-NR	TVH-KEY		
6	4	20	85	E	no	648	108TA5023	141TA2815	
7	4	22	56	B	no	E30	108TA4994	108TA4885	
7	4	22	57	B	no	14109108	108TA5008	108TA4961	
7	4	22	61	BC	no			141TA2434	

type of plug

4.2

4B

REF [141TA2815](#)

4.2

4B

REF [108TA4885](#)

4.2

4H

REF [108TA4961](#)

4.1

4E

REF [141TA2434](#)

If key number is not mentioned, there is no reference on the key or the key switch is supplied with different key numbers.



KEY SWITCHES

For all our latest catalogue updates and company info: www.tvh.com

KEY SWITCHES USED FOR HALLA - HYUNDAI

Number of connections	Number of positions	Dia (mm)	Total length (mm)	Type connection	Anti-restart	Key number	TVH-ref of key	REF switch with key	
QTY-CO	QTY-POS	D1	L1	TY-CO	AN-RE	KEY-NR	TVH-KEY		
3	2	22	59	E	no			141TA2591	
3	2	22	59	E	no			141TA2604	
3	2	22	59	E	no			141TA2616	
3	2	22	60	E	no			128TA5647	
3	3	22	60	E	no			108TA4926	
3	3	24	56	G	no			128TA5815	

2.1

2A

REF [141TA2591](#)

2.1

2A

REF [141TA2604](#)

2.1

2A

REF [141TA2616](#)

2.1

2A

REF [128TA5647](#)

3.1

3A

REF [108TA4926](#)

3.3

3A

REF [128TA5815](#)

If key number is not mentioned, there is no reference on the key or the key switch is supplied with different key numbers.

KEY SWITCHES

For all our latest catalogue updates and company info: www.tvh.com



KEY SWITCHES USED FOR HALLA - HYUNDAI

Number of connections	Number of positions	Dia (mm)	Total length (mm)	Type connection	Anti-restart	Key number	TVH-ref of key	REF switch with key	
QTY-CO	QTY-POS	D1	L1	TY-CO	AN-RE	KEY-NR	TVH-KEY		
4	3	24	40	G	no			128TA5789	
4	4	19	79	H	no			108TA4927	
6	3	20	83	E	no			128TA5780	
6	4	19	96	E	no			108TA4560	
6	4	20	74	E	no	001	108TA4990	110TA7797	
6	4	20	82	E	no		108TA5015	108TA4769	

type of plug

3.3

3A

REF [128TA5789](#)

4.1

4B

REF [108TA4927](#)

3.2

3B

REF [128TA5780](#)

4.2

4B

REF [108TA4560](#)

type of plug

4.2

4B

REF [110TA7797](#)

4.2

4B

REF [108TA4769](#)

If key number is not mentioned, there is no reference on the key or the key switch is supplied with different key numbers.



KEY SWITCHES

For all our latest catalogue updates and company info: www.tvh.com

KEY SWITCHES USED FOR HALLA - HYUNDAI

Number of connections	Number of positions	Dia (mm)	Total length (mm)	Type connection	Anti-restart	Key number	TVH-ref of key	REF switch with key	
QTY-CO	QTY-POS	D1	L1	TY-CO	AN-RE	KEY-NR	TVH-KEY		
6	4	20	82	E	no	D100	141TA2671	128TA5746	
6	4	20	85	CE	no	D100	141TA2671	128TA5830	
6	4	20	90	E	no			128TA5792	
8	3	24	41	D	no			116TA7786	
12	5	26	86	BC	yes	E30	108TA4994	141TA2530	

type of plug

4.2

4B

REF [128TA5746](#)

4.2

4B

REF [128TA5830](#)

type of plug

4.2

4B

REF [128TA5792](#)

3.3

3A

REF [116TA7786](#)

5.3

5F

REF [141TA2530](#)

If key number is not mentioned, there is no reference on the key or the key switch is supplied with different key numbers.

KEY SWITCHES



For all our latest catalogue updates and company info: www.tvh.com

KEY SWITCHES USED FOR HAMECH

Number of connections	Number of positions	Dia (mm)	Total length (mm)	Type connection	Anti-restart	Key number	TVH-ref of key	REF switch with key	
QTY-CO	QTY-POS	D1	L1	TY-CO	AN-RE	KEY-NR	TVH-KEY		
2	2	20	37	E	no			108TA4946	
4	2	19	42	A	no	TOK3	128TA5645	108TA4914	

2.1

2A

REF [108TA4946](#)

2.1

2A

REF [108TA4914](#)

If key number is not mentioned, there is no reference on the key or the key switch is supplied with different key numbers.



KEY SWITCHES

For all our latest catalogue updates and company info: www.tvh.com

KEY SWITCHES USED FOR HYSTER

Number of connections	Number of positions	Dia (mm)	Total length (mm)	Type connection	Anti-restart	Key number	TVH-ref of key	REF switch with key	
QTY-CO	QTY-POS	D1	L1	TY-CO	AN-RE	KEY-NR	TVH-KEY		
1	3	0	102	S	no		141TA2670	141TA3126	
2	2	12	31	G	no	83357	129TA4185	141TA2574	
2	2	16	63	E	no	8151	128TA5674	110TA3069	
2	2	18	52	G	no		128TA5674	115TA5379	
2	2	18	74	H	no			110TA3082	
2	2	19	43	B	no	2007	128TA5726	141TA2490	



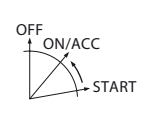

3.1

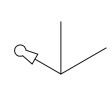

3A

REF [141TA3126](#)



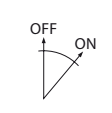

2.1



2A

REF [141TA2574](#)



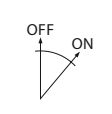

2.1



2A

REF [110TA3069](#)
With NO-contact



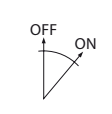

2.1

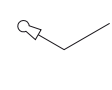

2A

REF [115TA5379](#)



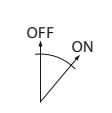

2.1

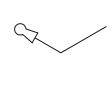

2A

REF [110TA3082](#)



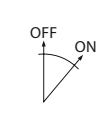

2.1

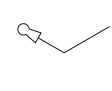

2A

REF [141TA2490](#)

If key number is not mentioned, there is no reference on the key or the key switch is supplied with different key numbers.

KEY SWITCHES

For all our latest catalogue updates and company info: www.tvh.com



KEY SWITCHES USED FOR HYSTER

Number of connections	Number of positions	Dia (mm)	Total length (mm)	Type connection	Anti-restart	Key number	TVH-ref of key	REF switch with key	
QTY-CO	QTY-POS	D1	L1	TY-CO	AN-RE	KEY-NR	TVH-KEY		
2	2	19	51	G	no			141TA2564	
2	2	19	62	B	no	CH512	118TA5814	110TA3063	
2	2	19	70	E	no	CH751	108TA5000	110TA3078	
2	2	20	37	E	no			108TA4945	
2	2	20	59	E	no	CH501	122TA8962	141TA3102	
2	2	20	71	E	no	NG100	129TA4188	141TA3129	

2.1

2A

REF [141TA2564](#)

2.1

2A

REF [110TA3063](#)

2.1

2A

REF [110TA3078](#)

2.1

2A

REF [108TA4945](#)

2.1

2A

REF [141TA3102](#)

2.1

2A

REF [141TA3129](#)

If key number is not mentioned, there is no reference on the key or the key switch is supplied with different key numbers.



KEY SWITCHES

For all our latest catalogue updates and company info: www.tvh.com

KEY SWITCHES USED FOR HYSTER

Number of connections	Number of positions	Dia (mm)	Total length (mm)	Type connection	Anti-restart	Key number	TVH-ref of key	REF switch with key	
QTY-CO	QTY-POS	D1	L1	TY-CO	AN-RE	KEY-NR	TVH-KEY		
2	2	22	62	E	no	455	108TA4991	128TA5610	
2	2	22	67	E	no	KN101	110TA3541	110TA3058	
2	2	22	72	E	no	455	108TA4991	141TA3158	
2	3	25	55	E	no			141TA2801	
3	2	20	54	B	no			110TA3084	
3	2	22	44	B	no			141TA3116	

REF [128TA5610](#)

2.1

2A

REF [110TA3058](#)

2.1

2A

REF [141TA3158](#)

2.1

2A

REF [141TA2801](#)

3.1

3A

REF [110TA3084](#)

2.1

2A

REF [141TA3116](#)

2.1

2A

If key number is not mentioned, there is no reference on the key or the key switch is supplied with different key numbers.

KEY SWITCHES

For all our latest catalogue updates and company info: www.tvh.com



KEY SWITCHES USED FOR HYSTER

Number of connections	Number of positions	Dia (mm)	Total length (mm)	Type connection	Anti-restart	Key number	TVH-ref of key	REF switch with key	
QTY-CO	QTY-POS	D1	L1	TY-CO	AN-RE	KEY-NR	TVH-KEY		
3	2	22	47	B	no	702	106TA2629	141TA3062	
3	3	16	61	E	no	83353	108TA4989	110TA3086	
3	3	16	80	B	no			128TA5997	
3	3	18	78	B	yes	748	141TA2661	141TA2784	
3	3	20	63	B	no			141TA3013	
3	3	22	46	B	no			108TA4709	

2.1

2A

REF [141TA3062](#)

3.1

3A

REF [110TA3086](#)

3.1

3G

REF [128TA5997](#)

3.1

3A

REF [141TA2784](#)

3.1

3A

REF [141TA3013](#)

3.2

3D

REF [108TA4709](#)

If key number is not mentioned, there is no reference on the key or the key switch is supplied with different key numbers.



KEY SWITCHES

For all our latest catalogue updates and company info: www.tvh.com

KEY SWITCHES USED FOR HYSTER

Number of connections	Number of positions	Dia (mm)	Total length (mm)	Type connection	Anti-restart	Key number	TVH-ref of key	REF switch with key	
QTY-CO	QTY-POS	D1	L1	TY-CO	AN-RE	KEY-NR	TVH-KEY		
3	3	22	52	B	yes	E30 BOSCH K11		110TA3028	
3	3	22	52	B	yes		141TA2659	118TA5745	
3	3	22	52	B	yes		108TA5017	118TA5747	
3	3	25	47	F	yes		110TA3255	141TA2865	
4	3	16	60	E	no			141TA2910	
4	3	19	45	G	no			123TA5702	

3.1

3A

REF [110TA3028](#)

3.1

3A

REF [118TA5745](#)

3.1

3A

REF [118TA5747](#)

3.1

3A

REF [141TA2865](#)

3.1

3G

REF [141TA2910](#)

3.1

3A

REF [123TA5702](#)

If key number is not mentioned, there is no reference on the key or the key switch is supplied with different key numbers.

KEY SWITCHES

For all our latest catalogue updates and company info: www.tvh.com



KEY SWITCHES USED FOR HYSTER

Number of connections	Number of positions	Dia (mm)	Total length (mm)	Type connection	Anti-restart	Key number	TVH-ref of key	REF switch with key	
QTY-CO	QTY-POS	D1	L1	TY-CO	AN-RE	KEY-NR	TVH-KEY		
4	3	20	63	B	no			110TA3052	
4	4	18	64	B	no			141TA2932	
4	4	18	74	B	no			110TA3047	
4	4	18	76	B	yes			141TA3140	
4	4	19	63	E	no			110TA3076	
4	4	19	70	H	yes			141TA3071	

3.1

3A

REF [110TA3052](#)

4.2

4B

REF [141TA2932](#)

4.1

4B

REF [110TA3047](#)

4.2

4I

REF [141TA3140](#)

4.2

4H

REF [110TA3076](#)

4.1

4I

REF [141TA3071](#)

If key number is not mentioned, there is no reference on the key or the key switch is supplied with different key numbers.



KEY SWITCHES

For all our latest catalogue updates and company info: www.tvh.com

KEY SWITCHES USED FOR HYSTER

Number of connections	Number of positions	Dia (mm)	Total length (mm)	Type connection	Anti-restart	Key number	TVH-ref of key	REF switch with key	
QTY-CO	QTY-POS	D1	L1	TY-CO	AN-RE	KEY-NR	TVH-KEY		
4	4	19	79	H	no			110TA8048	
4	4	25	62	E	yes		110TA3256	141TA2778	
5	2	22	56	B	no	K03	108TA4996	118TA5746	
5	3	25	62	E	yes			110TA8258	
5	4	22	59	E	yes	E30	108TA4994	118TA5748	
5	4	22	65	E	yes	E30	108TA4994	110TA3026	

4.1

4B

REF [110TA8048](#)

4.1

4B

REF [141TA2778](#)

2.1

2A

REF [118TA5746](#)

3.1

3A

REF [110TA8258](#)

4.5

4B

REF [118TA5748](#)

4.3

4A

REF [110TA3026](#)

If key number is not mentioned, there is no reference on the key or the key switch is supplied with different key numbers.

KEY SWITCHES

For all our latest catalogue updates and company info: www.tvh.com



KEY SWITCHES USED FOR HYSTER

Number of connections	Number of positions	Dia (mm)	Total length (mm)	Type connection	Anti-restart	Key number	TVH-ref of key	REF switch with key	
QTY-CO	QTY-POS	D1	L1	TY-CO	AN-RE	KEY-NR	TVH-KEY		
5	4	25	64	E	yes			110TA8260	
6	2	22	77	E	no	KN101	110TA3541	110TA3068	
6	3	22	65	B	no	E80	108TA5005	110TA3036	
6	3	25	55	D	yes	HYSTER	129TA3559	106TA2657	
6	4	16	65	BC	no	LUCAS	141TA2658	110TA3056	
6	4	19	96	E	no			141TA2851	

4.1

4B

REF [110TA8260](#)

2.1

2A

REF [110TA3068](#)

3.1

3A

REF [110TA3036](#)

3.1

3A

REF [106TA2657](#)

4.4

4A

REF [110TA3056](#)

4.2

4B

REF [141TA2851](#)

If key number is not mentioned, there is no reference on the key or the key switch is supplied with different key numbers.



KEY SWITCHES

For all our latest catalogue updates and company info: www.tvh.com

KEY SWITCHES USED FOR HYSTER

Number of connections	Number of positions	Dia (mm)	Total length (mm)	Type connection	Anti-restart	Key number	TVH-ref of key	REF switch with key	
QTY-CO	QTY-POS	D1	L1	TY-CO	AN-RE	KEY-NR	TVH-KEY		
6	4	20	74	E	no	001	108TA4990	141TA2948	
6	4	20	74	E	no	001	108TA4990	141TA2969	
6	4	20	74	E	no	001	108TA4990	141TA2990	
6	4	20	86	E	no			141TA3035	
6	4	20	86	E	no			118TA5755	
6	4	22	59	B	yes	K30	108TA5014	118TA5749	

4.2

4B

REF [141TA2948](#)

4.2

4B

REF [141TA2969](#)

4.2

4B

REF [141TA2990](#)

4.2

4B

REF [141TA3035](#)

4.2

4B

REF [118TA5755](#)

4.5

4B

REF [118TA5749](#)

If key number is not mentioned, there is no reference on the key or the key switch is supplied with different key numbers.

KEY SWITCHES

For all our latest catalogue updates and company info: www.tvh.com



KEY SWITCHES USED FOR HYSTER

Number of connections	Number of positions	Dia (mm)	Total length (mm)	Type connection	Anti-restart	Key number	TVH-ref of key	REF switch with key	
QTY-CO	QTY-POS	D1	L1	TY-CO	AN-RE	KEY-NR	TVH-KEY		
6	4	25	76	E	no	1500 HYSTER		118TA5743	
6	4	25	78	E	no			141TA3154	
6	5	32	83	B	no			118TA5756	
6	6	22	104	BH	no		108TA5020	110TA3064	
7	3	25	54	BD	yes		129TA3559	123TA5704	
7	3	25	62	B	yes		129TA3664	141TA2923	

4.2

4B

REF [118TA5743](#)

4.2

4B

REF [141TA3154](#)

5.2

5B

REF [118TA5756](#)

6.1

6B

REF [110TA3064](#)

3.1

3A

REF [123TA5704](#)

3.1

3A

REF [141TA2923](#)

If key number is not mentioned, there is no reference on the key or the key switch is supplied with different key numbers.



KEY SWITCHES

For all our latest catalogue updates and company info: www.tvh.com

KEY SWITCHES USED FOR HYSTER

Number of connections	Number of positions	Dia (mm)	Total length (mm)	Type connection	Anti-restart	Key number	TVH-ref of key	REF switch with key	
QTY-CO	QTY-POS	D1	L1	TY-CO	AN-RE	KEY-NR	TVH-KEY		
7	3	25	62	B	yes		141TA2663	108TA4583	
7	3	25	67	B	yes		141TA2654	141TA3024	
7	4	26	78	BC	no	14603	141TA2654	110TA3038	
10	4	26	78	BC	no	14603	141TA2654	141TA3081	
10	5	22	65	B	yes	K80	108TA5029	118TA5744	
10	5	26	78	BC	no	14603	141TA2654	141TA2928	

3.1

3A

REF [108TA4583](#)

3.1

3G

REF [141TA3024](#)

4.1

4E

REF [110TA3038](#)

4.3

4A

REF [141TA3081](#)

5.3

5F

REF [118TA5744](#)

5.1

5F

REF [141TA2928](#)

If key number is not mentioned, there is no reference on the key or the key switch is supplied with different key numbers.

KEY SWITCHES

For all our latest catalogue updates and company info: www.tvh.com



KEY SWITCHES USED FOR ICEM

Number of connections	Number of positions	Dia (mm)	Total length (mm)	Type connection	Anti-restart	Key number	TVH-ref of key	REF switch with key	
QTY-CO	QTY-POS	D1	L1	TY-CO	AN-RE	KEY-NR	TVH-KEY		
2	2	22	68	F	no	3095	122TA8983	141TA2589	
3	2	22	44	B	no			108TA4832	

REF [141TA2589](#)

2.1

2A

REF [108TA4832](#)

2.1

2A

If key number is not mentioned, there is no reference on the key or the key switch is supplied with different key numbers.



KEY SWITCHES

For all our latest catalogue updates and company info: www.tvh.com

KEY SWITCHES USED FOR JCB

Number of connections	Number of positions	Dia (mm)	Total length (mm)	Type connection	Anti-restart	Key number	TVH-ref of key	REF switch with key	
QTY-CO	QTY-POS	D1	L1	TY-CO	AN-RE	KEY-NR	TVH-KEY		
5	4	28	68	E	no			141TA2586	
6	4	16	66	BC	no	LUCAS	141TA2658	141TA2513	
6	4	19	82	E	no	S450	141TA2673	141TA2617	
6	4	19	83	E	no	S450	141TA2672	141TA2553	
6	3	26	82	BC	yes			141TA2609	

REF [141TA2586](#)

4.2

4B

REF [141TA2513](#)

4.4

4A

REF [141TA2617](#)

4.2

4B

REF [141TA2553](#)

4.2

4B

REF [141TA2609](#)

3.1

4A

If key number is not mentioned, there is no reference on the key or the key switch is supplied with different key numbers.

KEY SWITCHES

For all our latest catalogue updates and company info: www.tvh.com



KEY SWITCHES USED FOR JLG

Number of connections	Number of positions	Dia (mm)	Total length (mm)	Type connection	Anti-restart	Key number	TVH-ref of key	REF switch with key	
QTY-CO	QTY-POS	D1	L1	TY-CO	AN-RE	KEY-NR	TVH-KEY		
2	2	21	75	E	no	83357	129TA4185	141TA2500	
3	3	16	65	E	no			126TA4747	
3	3	20	75	E	no			141TA2571	
4	3	22	48	E	no	9901	139TA1766		
4	3	22	54	E	no		116TA5614	116TA5612	
4	3	22	64	E	no			110TA3077	

2.1

2A

REF [141TA2500](#)

3.1

3A

REF [126TA4747](#)

3.1

3A

REF [141TA2571](#)

3.2

3F

REF [139TA1766](#)

3.3

3D

REF [116TA5612](#)

3.2

3F

REF [110TA3077](#)

If key number is not mentioned, there is no reference on the key or the key switch is supplied with different key numbers.



KEY SWITCHES

For all our latest catalogue updates and company info: www.tvh.com

KEY SWITCHES USED FOR JLG

Number of connections	Number of positions	Dia (mm)	Total length (mm)	Type connection	Anti-restart	Key number	TVH-ref of key	REF switch with key	
QTY-CO	QTY-POS	D1	L1	TY-CO	AN-RE	KEY-NR	TVH-KEY		
4	4	19	70	H	yes	D250	141TA2674	141TA3072	
4	4	19	79	H	no			141TA2809	
4	4	25	80	H	yes			141TA2573	
5	3	25	81	E	yes			126TA5398	
5	4	20	74	E	no			141TA2545	
5	4	28	69	E	no			141TA2916	

4.1

4I

REF [141TA3072](#)

4.1

4B

REF [141TA2809](#)

4.1

4B

REF [141TA2573](#)

3.1

3G

REF [126TA5398](#)

4.7

4A

REF [141TA2545](#)

4.2

4B

REF [141TA2916](#)

If key number is not mentioned, there is no reference on the key or the key switch is supplied with different key numbers.

KEY SWITCHES

For all our latest catalogue updates and company info: www.tvh.com



KEY SWITCHES USED FOR JLG

Number of connections	Number of positions	Dia (mm)	Total length (mm)	Type connection	Anti-restart	Key number	TVH-ref of key	REF switch with key	
QTY-CO	QTY-POS	D1	L1	TY-CO	AN-RE	KEY-NR	TVH-KEY		
6	3	19	55	E	no	CH650	110TA3437	126TA4750	
6	3	19	56	E	no	CH650	110TA3437	110TA3085	
6	3	22	54	E	no	9901	116TA5614	116TA5613	
6	3	22	54	E	no	9901	116TA5614	126TA4752	
6	3	22	54	E	no	3000	128TA5987	141TA2590	
6	3	22	55	E	no	9901	116TA5614	123TA5706	

3.1

3B

REF [126TA4750](#)

3.1

3D

REF [110TA3085](#)

3.2

3D

REF [116TA5613](#)

3.2

3B

REF [126TA4752](#)

3.2

3F

REF [141TA2590](#)

3.2

3F

REF [123TA5706](#)

If key number is not mentioned, there is no reference on the key or the key switch is supplied with different key numbers.



KEY SWITCHES

For all our latest catalogue updates and company info: www.tvh.com

KEY SWITCHES USED FOR JLG

Number of connections	Number of positions	Dia (mm)	Total length (mm)	Type connection	Anti-restart	Key number	TVH-ref of key	REF switch with key	
QTY-CO	QTY-POS	D1	L1	TY-CO	AN-RE	KEY-NR	TVH-KEY		
6	3	22	55	E	no	3000	128TA5987	141TA2515	
6	3	22	55	E	no	9901	116TA5614	141TA2582	
7	4	16	65	BC	no	LUCAS	141TA2658	141TA2974	
8	3	22	88	E	no			110TA3015	
8	3	22	99	E	no	455	110TA3210	141TA2579	
9	4	26	78	BC	yes	14603	141TA2654	141TA2559	

REF [141TA2515](#)

3.2

3F

REF [141TA2582](#)

3.8

3B

REF [141TA2974](#)

4.4

4A

REF [110TA3015](#)

3.2

3D

REF [141TA2579](#)

3.2

3F

REF [141TA2559](#)

4.4

4A

If key number is not mentioned, there is no reference on the key or the key switch is supplied with different key numbers.

KEY SWITCHES



For all our latest catalogue updates and company info: www.tvh.com

KEY SWITCHES USED FOR JLG

Number of connections	Number of positions	Dia (mm)	Total length (mm)	Type connection	Anti-restart	Key number	TVH-ref of key	REF switch with key	
QTY-CO	QTY-POS	D1	L1	TY-CO	AN-RE	KEY-NR	TVH-KEY		
12	3	22	,5	E	no	455	141TA2675	141TA2610	
12	5	26	87	BC	yes			141TA2572	



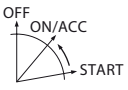

3.1



3C

REF [141TA2610](#)





5.1



5F

REF [141TA2572](#)

If key number is not mentioned, there is no reference on the key or the key switch is supplied with different key numbers.



KEY SWITCHES

For all our latest catalogue updates and company info: www.tvh.com

KEY SWITCHES USED FOR JUNGHEINRICH

Number of connections	Number of positions	Dia (mm)	Total length (mm)	Type connection	Anti-restart	Key number	TVH-ref of key	REF switch with key	
QTY-CO	QTY-POS	D1	L1	TY-CO	AN-RE	KEY-NR	TVH-KEY		
2	2	15	53	H	no	601	141TA2656	110TA7647	
2	2	15	53	H	no	684	108TA4988	141TA2943	
2	2	18	74	H	no			141TA3021	
2	2	19	51	E	no	NG100	129TA4188	141TA2538	
2	2	19	62	B	no	CH512	118TA5814	110TA7958	
3	2	22	47	B	no	702	106TA2629	110TA7594	

2.1

2A

REF [110TA7647](#)

2.1

2A

REF [141TA2943](#)

2.1

2A

REF [141TA3021](#)

2.1

2A

REF [141TA2538](#)

2.1

2A

REF [110TA7958](#)

2.1

2A

REF [110TA7594](#)

If key number is not mentioned, there is no reference on the key or the key switch is supplied with different key numbers.

KEY SWITCHES

For all our latest catalogue updates and company info: www.tvh.com



KEY SWITCHES USED FOR JUNGHEINRICH

Number of connections	Number of positions	Dia (mm)	Total length (mm)	Type connection	Anti-restart	Key number	TVH-ref of key	REF switch with key	
QTY-CO	QTY-POS	D1	L1	TY-CO	AN-RE	KEY-NR	TVH-KEY		
3	2	22	47	B	no	701	108TA4993	116TA5603	
3	2	22	48	B	no	501	106TA2631	108TA4751	
3	2	22	48	B	no	508	108TA5016	108TA4918	
3	2	22	48	B	no	9401	122TA8945	123TA5708	
3	2	22	48,5	B	no	702	108TA4992	128TA5978	
3	2	22	49	B	no	503	106TA2635	110TA7683	

2.1

2A

REF [116TA5603](#)

2.1

2A

REF [108TA4751](#)

2.1

2A

REF [108TA4918](#)

2.1

2A

REF [123TA5708](#)

2.1

2A

REF [128TA5978](#)

2.1

2A

REF [110TA7683](#)

If key number is not mentioned, there is no reference on the key or the key switch is supplied with different key numbers.



KEY SWITCHES

For all our latest catalogue updates and company info: www.tvh.com

KEY SWITCHES USED FOR JUNGHEINRICH

Number of connections	Number of positions	Dia (mm)	Total length (mm)	Type connection	Anti-restart	Key number	TVH-ref of key	REF switch with key	
QTY-CO	QTY-POS	D1	L1	TY-CO	AN-RE	KEY-NR	TVH-KEY		
3	2	22	49	B	no	E254	108TA5012	116TA7781	
3	2	22	49	B	no		108TA4982		
3	2	22	53	B	no	701	108TA4993	110TA7507	
3	2	22	53	B	no		141TA2528		
3	2	22	69	B	no	606	141TA2665	141TA2565	
3	3	22	52	B	yes	K11	108TA5017	110TA7836	

2.1

2A

REF [116TA7781](#)

2.1

2A

REF [108TA4982](#)

2.1

2A

REF [110TA7507](#)

2.1

2D

REF [141TA2528](#)

2.1

2A

REF [141TA2565](#)

3.1

3A

REF [110TA7836](#)

If key number is not mentioned, there is no reference on the key or the key switch is supplied with different key numbers.

KEY SWITCHES

For all our latest catalogue updates and company info: www.tvh.com



KEY SWITCHES USED FOR JUNGHEINRICH

Number of connections	Number of positions	Dia (mm)	Total length (mm)	Type connection	Anti-restart	Key number	TVH-ref of key	REF switch with key	
QTY-CO	QTY-POS	D1	L1	TY-CO	AN-RE	KEY-NR	TVH-KEY		
4	2	19	55	B	no			141TA2424	
4	2	20	54	B	no			116TA7778	
4	2	22	50	B	no	738	110TA3353	110TA8152	
4	2	22	65	B	no			141TA2546	
4	2	22	65	E	no	455	108TA4991	141TA2587	
4	2	22	74	B	no	T251	110TA3494	108TA4964	

2.1

2A

REF [141TA2424](#)

2.1

2A

REF [116TA7778](#)

2.1

2A

REF [110TA8152](#)

2.1

2A

REF [141TA2546](#)

2.1

2C

REF [141TA2587](#)

2.1

2B

REF [108TA4964](#)

If key number is not mentioned, there is no reference on the key or the key switch is supplied with different key numbers.



KEY SWITCHES

For all our latest catalogue updates and company info: www.tvh.com

KEY SWITCHES USED FOR JUNGHEINRICH

Number of connections	Number of positions	Dia (mm)	Total length (mm)	Type connection	Anti-restart	Key number	TVH-ref of key	REF switch with key	
QTY-CO	QTY-POS	D1	L1	TY-CO	AN-RE	KEY-NR	TVH-KEY		
4	2	30	60	B	no	3A36	108TA5019	108TA4916	
4	3	19	55	B	no			128TA5603	
4	3	20	63	B	no			110TA7869	
4	4	18	66	B	yes	14644	108TA5013	141TA3094	
4	4	19	79	H	no			110TA8112	
4	4	22	65	B	yes	606	141TA2665	141TA2593	

2.1

2C

REF [108TA4916](#)

3.2

3B

REF [128TA5603](#)

3.1

3A

REF [110TA7869](#)

4.7

4A

REF [141TA3094](#)

4.1

4B

REF [110TA8112](#)

4.7

4A

REF [141TA2593](#)

If key number is not mentioned, there is no reference on the key or the key switch is supplied with different key numbers.

KEY SWITCHES

For all our latest catalogue updates and company info: www.tvh.com



KEY SWITCHES USED FOR JUNGHEINRICH

Number of connections	Number of positions	Dia (mm)	Total length (mm)	Type connection	Anti-restart	Key number	TVH-ref of key	REF switch with key	
QTY-CO	QTY-POS	D1	L1	TY-CO	AN-RE	KEY-NR	TVH-KEY		
5	2	22	56	B	no			108TA4663	
5	2	22	56	B	no	K03	108TA4996	141TA2886	
5	3	18	66	B	yes	14644	108TA5013	141TA3027	
5	4	22	59	E	yes			108TA4754	
5	4	22	65	E	yes	E30	108TA4994	110TA7670	
6	4	16	65	BC	no	LUCAS	141TA2658	108TA4741	

2.1

2A

REF [108TA4663](#)

2.1

2A

REF [141TA2886](#)

3.1

3A

REF [141TA3027](#)

4.5

4B

REF [108TA4754](#)

4.3

4A

REF [110TA7670](#)

4.4

4A

REF [108TA4741](#)

If key number is not mentioned, there is no reference on the key or the key switch is supplied with different key numbers.



KEY SWITCHES

For all our latest catalogue updates and company info: www.tvh.com

KEY SWITCHES USED FOR JUNGHEINRICH

Number of connections	Number of positions	Dia (mm)	Total length (mm)	Type connection	Anti-restart	Key number	TVH-ref of key	REF switch with key	
QTY-CO	QTY-POS	D1	L1	TY-CO	AN-RE	KEY-NR	TVH-KEY		
6	4	28	95	E	no	5154	129TA4124	108TA4966	
6	6	22	104	BH	no	1500	108TA5020	110TA7974	
7	3	25	62	B	yes		141TA2663	110TA7525	
8	2	16	45	G	no			141TA2446	
10	5	22	65	B	yes	K80	108TA5029	141TA2716	
10	5	26	78	BC	no	14603	141TA2654	108TA4600	

4.2

4B

REF [108TA4966](#)

6.1

6B

REF [110TA7974](#)

3.1

3A

REF [110TA7525](#)

2.1

2C

REF [141TA2446](#)

5.3

5F

REF [141TA2716](#)

5.1

5F

REF [108TA4600](#)

If key number is not mentioned, there is no reference on the key or the key switch is supplied with different key numbers.

KEY SWITCHES

For all our latest catalogue updates and company info: www.tvh.com

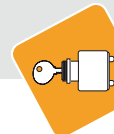

KEY SWITCHES USED FOR JUNGHEINRICH

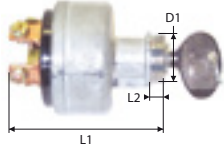
Number of connections	Number of positions	Dia (mm)	Total length (mm)	Type connection	Anti-restart	Key number	TVH-ref of key	REF switch with key	
QTY-CO	QTY-POS	D1	L1	TY-CO	AN-RE	KEY-NR	TVH-KEY		
10	5	26	78	BC	yes	14607	110TA3492	141TA2489	



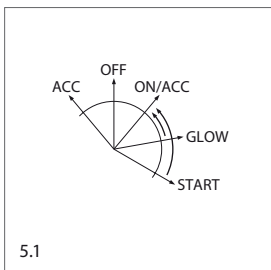

5.1



5F

REF [141TA2489](#)

If key number is not mentioned, there is no reference on the key or the key switch is supplied with different key numbers.



KEY SWITCHES

For all our latest catalogue updates and company info: www.tvh.com

KEY SWITCHES USED FOR KALMAR

Number of connections	Number of positions	Dia (mm)	Total length (mm)	Type connection	Anti-restart	Key number	TVH-ref of key	REF switch with key	
QTY-CO	QTY-POS	D1	L1	TY-CO	AN-RE	KEY-NR	TVH-KEY		
2	2	16	63	E	no	83357	129TA4185	141TA3084	
2	2	18	74	H	no			141TA3022	
2	2	19	50	E	no			141TA2606	
3	3	20	81	E	no			108TA4796	
3	3	25	56	E	no			108TA4840	
4	2	19	54	G	no			141TA2473	



With NO-contact

REF [141TA3084](#)

2.1

2A



REF [141TA3022](#)

2.1

2A



REF [141TA2606](#)

2.1

2D



REF [108TA4796](#)

3.1

3A



REF [108TA4840](#)

3.1

3A



REF [141TA2473](#)

2.1

2C

If key number is not mentioned, there is no reference on the key or the key switch is supplied with different key numbers.

KEY SWITCHES

For all our latest catalogue updates and company info: www.tvh.com



KEY SWITCHES USED FOR KALMAR

Number of connections	Number of positions	Dia (mm)	Total length (mm)	Type connection	Anti-restart	Key number	TVH-ref of key	REF switch with key	
QTY-CO	QTY-POS	D1	L1	TY-CO	AN-RE	KEY-NR	TVH-KEY		
4	2	22	72	E	no	14603	141TA2654	141TA2598	
4	2	26	78	BC	no			141TA2963	
4	3	19	55	B	no			110TA8046	
4	4	19	79	H	no			141TA2810	
5	2	22	56	B	no	E41	108TA4995	108TA4764	
5	4	22	59	E	yes	E30	108TA4994	141TA2704	

REF [141TA2598](#)

2.1

2A

REF [141TA2963](#)

2.1

2A

REF [110TA8046](#)

3.2

3B

REF [141TA2810](#)

4.1

4B

REF [108TA4764](#)

2.1

2A

REF [141TA2704](#)

4.5

4B

If key number is not mentioned, there is no reference on the key or the key switch is supplied with different key numbers.



KEY SWITCHES

For all our latest catalogue updates and company info: www.tvh.com

KEY SWITCHES USED FOR KALMAR

Number of connections	Number of positions	Dia (mm)	Total length (mm)	Type connection	Anti-restart	Key number	TVH-ref of key	REF switch with key	
QTY-CO	QTY-POS	D1	L1	TY-CO	AN-RE	KEY-NR	TVH-KEY		
5	4	22	65	E	yes	E30	108TA4994	108TA4626	
5	4	25	64	E	yes			141TA2830	
6	4	16	65	BC	no	LUCAS	141TA2658	110TA7915	
6	4	19	96	E	no			108TA4559	
6	4	20	74	E	no	001	108TA4990	141TA2949	
6	4	20	74	E	no	001	108TA4990	141TA2991	

4.3

4A

REF [108TA4626](#)

4.1

4B

REF [141TA2830](#)

4.4

4A

REF [110TA7915](#)

4.2

4B

REF [108TA4559](#)

4.2

4B

REF [141TA2949](#)

4.2

4B

REF [141TA2991](#)

If key number is not mentioned, there is no reference on the key or the key switch is supplied with different key numbers.

KEY SWITCHES

For all our latest catalogue updates and company info: www.tvh.com



KEY SWITCHES USED FOR KALMAR

Number of connections	Number of positions	Dia (mm)	Total length (mm)	Type connection	Anti-restart	Key number	TVH-ref of key	REF switch with key	
QTY-CO	QTY-POS	D1	L1	TY-CO	AN-RE	KEY-NR	TVH-KEY		
6	4	22	59	B	yes			108TA4785	
6	5	32	83	B	no			116TA5598	
10	5	22	65	B	yes			110TA7976	
10	5	26	78	BC	no	14603	141TA2654	110TA7641	
10	5	26	78	BC	no	14603	141TA2654	141TA2847	

REF [108TA4785](#)

4.5

4B

REF [116TA5598](#)

5.2

5B

REF [110TA7976](#)

5.3

5F

REF [110TA7641](#)

5.1

5F

REF [141TA2847](#)

5.6

5F

If key number is not mentioned, there is no reference on the key or the key switch is supplied with different key numbers.



KEY SWITCHES

For all our latest catalogue updates and company info: www.tvh.com

KEY SWITCHES USED FOR KOMATSU

Number of connections	Number of positions	Dia (mm)	Total length (mm)	Type connection	Anti-restart	Key number	TVH-ref of key	REF switch with key	
QTY-CO	QTY-POS	D1	L1	TY-CO	AN-RE	KEY-NR	TVH-KEY		
2	2	15	53	H	no	601	141TA2656	108TA4606	
2	2	16	63	E	no	83357	129TA4185	141TA3085	
2	2	19	43	B	no	2007	128TA5726	141TA3078	
2	2	19	62	B	no	CH512	118TA5814	141TA3097	
2	2	22	50	B	no			116TA7790	
2	2	25	58	E	no			141TA2512	

2.1

2A

REF [108TA4606](#)

2.1

2A

REF [141TA3085](#)

2.1

2A

REF [141TA3078](#)

2.1

2A

REF [141TA3097](#)

2.1

2A

REF [116TA7790](#)

2.1

2A

REF [141TA2512](#)

If key number is not mentioned, there is no reference on the key or the key switch is supplied with different key numbers.

KEY SWITCHES

For all our latest catalogue updates and company info: www.tvh.com



KEY SWITCHES USED FOR KOMATSU

Number of connections	Number of positions	Dia (mm)	Total length (mm)	Type connection	Anti-restart	Key number	TVH-ref of key	REF switch with key	
QTY-CO	QTY-POS	D1	L1	TY-CO	AN-RE	KEY-NR	TVH-KEY		
2	3	25	55	E	no	A126	128TA5701	110TA7970	
3	2	21	40	G	no			108TA4564	
3	2	22	38	B	no			116TA7771	
3	2	22	44	B	no			115TA5374	
3	2	22	47	B	no	702	106TA2629	141TA3065	
3	2	22	47	E	no	P27	141TA2676	128TA5751	

3.1

3A

REF [110TA7970](#)

2.1

2A

REF [108TA4564](#)

2.1

2A

REF [116TA7771](#)

2.1

2A

REF [115TA5374](#)

2.1

2A

REF [141TA3065](#)

2.1

2A

REF [128TA5751](#)

If key number is not mentioned, there is no reference on the key or the key switch is supplied with different key numbers.



KEY SWITCHES

For all our latest catalogue updates and company info: www.tvh.com

KEY SWITCHES USED FOR KOMATSU

Number of connections	Number of positions	Dia (mm)	Total length (mm)	Type connection	Anti-restart	Key number	TVH-ref of key	REF switch with key	
QTY-CO	QTY-POS	D1	L1	TY-CO	AN-RE	KEY-NR	TVH-KEY		
3	2	22	48	B	no	530	106TA2637	141TA2726	
3	2	22	48	B	no	501	106TA2631	108TA4748	
3	2	22	49	B	no	801	108TA5025	141TA3169	
3	2	22	49	B	no	E254	108TA5012	108TA4870	
3	2	22	49	B	no	802	108TA5030	128TA5654	
3	2	22	49	B	no		110TA8278		

REF [141TA2726](#)

2.1

2A

REF [108TA4748](#)

2.1

2A

REF [141TA3169](#)

2.1

2A

REF [108TA4870](#)

2.1

2A

REF [128TA5654](#)

2.1

2A

REF [110TA8278](#)

2.1

2A

If key number is not mentioned, there is no reference on the key or the key switch is supplied with different key numbers.

KEY SWITCHES

For all our latest catalogue updates and company info: www.tvh.com



KEY SWITCHES USED FOR KOMATSU

Number of connections	Number of positions	Dia (mm)	Total length (mm)	Type connection	Anti-restart	Key number	TVH-ref of key	REF switch with key	
QTY-CO	QTY-POS	D1	L1	TY-CO	AN-RE	KEY-NR	TVH-KEY		
3	2	22	53	B	no	701	108TA4993	108TA4573	
3	3	16	65	E	no	83357	129TA4185	141TA2873	
3	3	16	80	B	no			141TA2906	
3	3	18	65	B	no	14644	108TA5013	108TA4780	
3	3	20	63	B	no			128TA5652	
3	3	20	81	E	no			108TA4793	

2.1

2A

REF [108TA4573](#)

3.2

3F

REF [141TA2873](#)

3.1

3G

REF [141TA2906](#)

3.3

3A

REF [108TA4780](#)

3.1

3A

REF [128TA5652](#)

3.1

3A

REF [108TA4793](#)

If key number is not mentioned, there is no reference on the key or the key switch is supplied with different key numbers.



KEY SWITCHES

For all our latest catalogue updates and company info: www.tvh.com

KEY SWITCHES USED FOR KOMATSU

Number of connections	Number of positions	Dia (mm)	Total length (mm)	Type connection	Anti-restart	Key number	TVH-ref of key	REF switch with key	
QTY-CO	QTY-POS	D1	L1	TY-CO	AN-RE	KEY-NR	TVH-KEY		
3	3	22	46	B	no			116TA7770	
3	3	22	52	B	yes			108TA4635	
3	3	22	53	B	no			115TA5381	
3	3	25	56	E	no			141TA2978	
3	3	25	56	E	no	T800A	108TA5006	141TA2817	
3	3	25	56	E	no	T800A	108TA5006	141TA3162	

REF [116TA7770](#)

3.2

3D

REF [108TA4635](#)

3.1

3A

REF [115TA5381](#)

3.2

3D

REF [141TA2978](#)

3.1

3A

REF [141TA2817](#)

3.1

3A

REF [141TA3162](#)

3.1

3A

If key number is not mentioned, there is no reference on the key or the key switch is supplied with different key numbers.

KEY SWITCHES

For all our latest catalogue updates and company info: www.tvh.com



KEY SWITCHES USED FOR KOMATSU

Number of connections	Number of positions	Dia (mm)	Total length (mm)	Type connection	Anti-restart	Key number	TVH-ref of key	REF switch with key	
QTY-CO	QTY-POS	D1	L1	TY-CO	AN-RE	KEY-NR	TVH-KEY		
4	2	16	37	G	no	311	141TA2669	116TA7784	
4	2	20	54	B	no			108TA4814	
4	2	22	50	B	no	738	110TA3353	128TA5620	
4	2	26	78	BC	no	14603	141TA2654	141TA2964	
4	2	30	82	E	no	3095	129TA4021	128TA5632	
4	3	20	63	B	yes			128TA5662	

2.1

2A

REF [116TA7784](#)

2.1

2A

REF [108TA4814](#)

2.1

2A

REF [128TA5620](#)

2.1

2A

REF [141TA2964](#)

2.1

2C

REF [128TA5632](#)

3.1

3A

REF [128TA5662](#)

If key number is not mentioned, there is no reference on the key or the key switch is supplied with different key numbers.



KEY SWITCHES

For all our latest catalogue updates and company info: www.tvh.com

KEY SWITCHES USED FOR KOMATSU

Number of connections	Number of positions	Dia (mm)	Total length (mm)	Type connection	Anti-restart	Key number	TVH-ref of key	REF switch with key	
QTY-CO	QTY-POS	D1	L1	TY-CO	AN-RE	KEY-NR	TVH-KEY		
4	3	20	63	B	no	LUCAS		141TA3109	
4	4	16	66	BC	no		141TA2658	141TA3160	
4	4	19	70	H	yes			141TA2488	
4	4	25	62	E	yes		110TA3256	141TA2779	
5	2	22	56	B	no	E30	108TA4994	141TA2764	
5	2	22	56	B	no	K03	108TA4996	141TA2887	

3.1

3A

REF [141TA3109](#)

4.8

4C

REF [141TA3160](#)

4.1

4I

REF [141TA2488](#)

4.1

4B

REF [141TA2779](#)

2.1

2A

REF [141TA2764](#)

2.1

2A

REF [141TA2887](#)

If key number is not mentioned, there is no reference on the key or the key switch is supplied with different key numbers.

KEY SWITCHES

For all our latest catalogue updates and company info: www.tvh.com



KEY SWITCHES USED FOR KOMATSU

Number of connections	Number of positions	Dia (mm)	Total length (mm)	Type connection	Anti-restart	Key number	TVH-ref of key	REF switch with key	
QTY-CO	QTY-POS	D1	L1	TY-CO	AN-RE	KEY-NR	TVH-KEY		
5	3	18	66	B	yes	14644	108TA5013	128TA5527	
5	3	20	55	B	no	FS880	108TA5024	116TA7793	
5	4	22	59	E	yes	E30	108TA4994	128TA5565	
5	4	22	65	E	yes	E30	108TA4994	123TA5715	
5	4	25	64	E	yes			141TA2831	
5	4	28	69	E	no			108TA4942	

3.1

3A

REF [128TA5527](#)

3.1

3A

REF [116TA7793](#)

4.5

4B

REF [128TA5565](#)

4.3

4A

REF [123TA5715](#)

4.1

4B

REF [141TA2831](#)

4.2

4B

REF [108TA4942](#)

If key number is not mentioned, there is no reference on the key or the key switch is supplied with different key numbers.





KEY SWITCHES

For all our latest catalogue updates and company info: www.tvh.com

KEY SWITCHES USED FOR KOMATSU

Number of connections	Number of positions	Dia (mm)	Total length (mm)	Type connection	Anti-restart	Key number	TVH-ref of key	REF switch with key	
QTY-CO	QTY-POS	D1	L1	TY-CO	AN-RE	KEY-NR	TVH-KEY		
6	2	20	82	E	no		108TA5015	108TA4913	
6	3	20	71	B	yes	U7800	128TA5782	128TA5781	
6	3	20	71	B	yes	U7800	128TA5782	141TA2532	
6	4	16	65	BC	no	LUCAS	141TA2658	128TA5572	
6	4	19	96	E	no			110TA7424	
6	4	20	72	F	no	648	108TA5023	141TA2893	





2.1

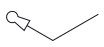

2A

REF [108TA4913](#)



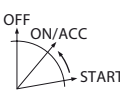

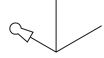

3.1



3A

REF [128TA5781](#)





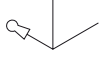

3.1



3A

REF [141TA2532](#)





4.4



4A

REF [128TA5572](#)



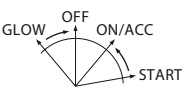

4.2

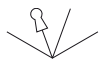

4B

REF [110TA7424](#)



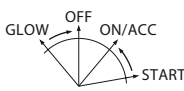

4.2

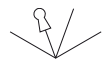

4B

REF [141TA2893](#)

If key number is not mentioned, there is no reference on the key or the key switch is supplied with different key numbers.

KEY SWITCHES

For all our latest catalogue updates and company info: www.tvh.com



KEY SWITCHES USED FOR KOMATSU

Number of connections	Number of positions	Dia (mm)	Total length (mm)	Type connection	Anti-restart	Key number	TVH-ref of key	REF switch with key	
QTY-CO	QTY-POS	D1	L1	TY-CO	AN-RE	KEY-NR	TVH-KEY		
6	4	20	72	E	no	100	108TA5022	128TA5813	
6	4	20	72	E	no	648	108TA5023	128TA5829	
6	4	20	72	E	no	100	108TA5022	141TA2555	
6	4	20	74	E	no	001	108TA4990	110TA7795	
6	4	20	74	E	no	001	108TA4990	110TA7921	
6	4	20	74	E	no	100	108TA5022	110TA8114	

type of plug

4.2

4B

REF [128TA5813](#)

type of plug

4.2

4B

REF [128TA5829](#)

type of plug

4.2

4B

REF [141TA2555](#)

type of plug

4.2

4B

REF [110TA7795](#)

type of plug

4.2

4B

REF [110TA7921](#)

type of plug

4.2

4B

REF [110TA8114](#)

If key number is not mentioned, there is no reference on the key or the key switch is supplied with different key numbers.



KEY SWITCHES

For all our latest catalogue updates and company info: www.tvh.com

KEY SWITCHES USED FOR KOMATSU

Number of connections	Number of positions	Dia (mm)	Total length (mm)	Type connection	Anti-restart	Key number	TVH-ref of key	REF switch with key	
QTY-CO	QTY-POS	D1	L1	TY-CO	AN-RE	KEY-NR	TVH-KEY		
6	4	20	74	E	no	001	108TA4990	108TA4883	
6	4	20	80	F	no	648	108TA5023	128TA5835	
6	4	20	82	E	no		108TA5015	108TA4767	
6	4	20	85	E	no	648	108TA5023	108TA4834	
6	4	20	86	E	no			110TA8245	
7	4	16	65	BC	no	LUCAS	141TA2658	108TA4803	

4.2

4B

REF [108TA4883](#)

4.2

4B

REF [128TA5835](#)

4.2

4B

REF [108TA4767](#)

4.2

4B

REF [108TA4834](#)

4.2

4B

REF [110TA8245](#)

4.4

4A

REF [108TA4803](#)

If key number is not mentioned, there is no reference on the key or the key switch is supplied with different key numbers.

KEY SWITCHES

For all our latest catalogue updates and company info: www.tvh.com



KEY SWITCHES USED FOR KOMATSU

Number of connections	Number of positions	Dia (mm)	Total length (mm)	Type connection	Anti-restart	Key number	TVH-ref of key	REF switch with key	
QTY-CO	QTY-POS	D1	L1	TY-CO	AN-RE	KEY-NR	TVH-KEY		
7	4	22	57	B	no	14109108	108TA5008	128TA5971	
8	3	24	41	D	no			123TA5717	
8	4	20	86	BE	no			110TA8172	
10	5	26	78	BC	no	14603	141TA2654	110TA7626	

REF [128TA5971](#)

4.2

4H

REF [123TA5717](#)

3.3

3A

REF [110TA8172](#)

4.2

4B

REF [110TA7626](#)

5.1

5F

If key number is not mentioned, there is no reference on the key or the key switch is supplied with different key numbers.



KEY SWITCHES

For all our latest catalogue updates and company info: www.tvh.com

KEY SWITCHES USED FOR LINDE - LANSING

Number of connections	Number of positions	Dia (mm)	Total length (mm)	Type connection	Anti-restart	Key number	TVH-ref of key	REF switch with key	
QTY-CO	QTY-POS	D1	L1	TY-CO	AN-RE	KEY-NR	TVH-KEY		
2	2	15	53	H	no	601	141TA2656	110TA7649	
2	2	15	53	H	no	684	108TA4988	108TA4655	
2	2	16	48	B	no	633	108TA5011	106TA2639	
2	2	16	48	B	no	695	108TA5010	106TA2641	
2	2	18	74	H	no			108TA4934	
2	2	20	49	E	no	FS880	108TA5024	141TA2788	

2.1

2A

REF [110TA7649](#)

2.1

2A

REF [108TA4655](#)

2.1

2A

REF [106TA2639](#)

2.1

2A

REF [106TA2641](#)

2.1

2A

REF [108TA4934](#)

2.1

2A

REF [141TA2788](#)

If key number is not mentioned, there is no reference on the key or the key switch is supplied with different key numbers.

KEY SWITCHES

For all our latest catalogue updates and company info: www.tvh.com



KEY SWITCHES USED FOR LINDE - LANSING

Number of connections	Number of positions	Dia (mm)	Total length (mm)	Type connection	Anti-restart	Key number	TVH-ref of key	REF switch with key	
QTY-CO	QTY-POS	D1	L1	TY-CO	AN-RE	KEY-NR	TVH-KEY		
2	2	22	50	B	no	455	108TA4991	115TA5393	
2	2	22	62	E	no			141TA2985	
3	2	22	38	B	no			141TA2958	
3	2	22	44	B	no			128TA5857	
3	2	22	48	B	no	530	106TA2637	141TA2727	
3	2	22	48	B	no	501	106TA2631	128TA5573	

2.1

2A

REF [115TA5393](#)

2.1

2A

REF [141TA2985](#)

2.1

2A

REF [141TA2958](#)

2.1

2A

REF [128TA5857](#)

2.1

2A

REF [141TA2727](#)

2.1

2A

REF [128TA5573](#)

If key number is not mentioned, there is no reference on the key or the key switch is supplied with different key numbers.



KEY SWITCHES

For all our latest catalogue updates and company info: www.tvh.com

KEY SWITCHES USED FOR LINDE - LANSING

Number of connections	Number of positions	Dia (mm)	Total length (mm)	Type connection	Anti-restart	Key number	TVH-ref of key	REF switch with key	
QTY-CO	QTY-POS	D1	L1	TY-CO	AN-RE	KEY-NR	TVH-KEY		
3	2	22	49	B	no	503	106TA2635	123TA5720	
3	2	22	49	B	no	801	108TA5025	141TA3170	
3	2	22	49	B	no	E254	108TA5012	108TA4874	
3	2	22	49	B	no	802	108TA5030	108TA4930	
3	2	22	49	B	no	9407	122TA8951	141TA2463	
3	2	22	49	B	no		141TA2594		

2.1

2A

REF [123TA5720](#)

2.1

2A

REF [141TA3170](#)

2.1

2A

REF [108TA4874](#)

2.1

2A

REF [108TA4930](#)

2.1

2A

REF [141TA2463](#)

2.1

2D

REF [141TA2594](#)

If key number is not mentioned, there is no reference on the key or the key switch is supplied with different key numbers.

KEY SWITCHES

For all our latest catalogue updates and company info: www.tvh.com



KEY SWITCHES USED FOR LINDE - LANSING

Number of connections	Number of positions	Dia (mm)	Total length (mm)	Type connection	Anti-restart	Key number	TVH-ref of key	REF switch with key	
QTY-CO	QTY-POS	D1	L1	TY-CO	AN-RE	KEY-NR	TVH-KEY		
3	2	22	55	E	no	6896	141TA2679	141TA2599	
3	3	16	61	E	no	83353	108TA4989	123TA5719	
3	3	16	65	E	no	83357	129TA4185	141TA2874	
3	3	22	46	B	no			108TA4712	
3	3	22	52	B	yes			141TA2708	
3	3	22	52	B	yes	K11	108TA5017	128TA5553	

2.1

2A

REF [141TA2599](#)

3.1

3A

REF [123TA5719](#)

3.2

3F

REF [141TA2874](#)

3.2

3D

REF [108TA4712](#)

3.1

3A

REF [141TA2708](#)

3.1

3A

REF [128TA5553](#)

If key number is not mentioned, there is no reference on the key or the key switch is supplied with different key numbers.



KEY SWITCHES

For all our latest catalogue updates and company info: www.tvh.com

KEY SWITCHES USED FOR LINDE - LANSING

Number of connections	Number of positions	Dia (mm)	Total length (mm)	Type connection	Anti-restart	Key number	TVH-ref of key	REF switch with key	
QTY-CO	QTY-POS	D1	L1	TY-CO	AN-RE	KEY-NR	TVH-KEY		
3	3	22	52	B	yes	E11	108TA5026	108TA4904	
3	3	22	53	B	no		115TA5383	115TA5383	
4	2	16	37	G	no	311	141TA2669	128TA5646	
4	2	19	49	G	no	93201	108TA5027	141TA3029	
4	2	20	54	B	no			110TA8040	
4	2	20	54	B	no	FS885	108TA5028	108TA4906	

3.1

3A

REF [108TA4904](#)

3.2

3D

REF [115TA5383](#)

2.1

2A

REF [128TA5646](#)

2.2

2A

REF [141TA3029](#)

2.1

2A

REF [110TA8040](#)

2.1

2A

REF [108TA4906](#)

If key number is not mentioned, there is no reference on the key or the key switch is supplied with different key numbers.

KEY SWITCHES

For all our latest catalogue updates and company info: www.tvh.com



KEY SWITCHES USED FOR LINDE - LANSING

Number of connections	Number of positions	Dia (mm)	Total length (mm)	Type connection	Anti-restart	Key number	TVH-ref of key	REF switch with key	
QTY-CO	QTY-POS	D1	L1	TY-CO	AN-RE	KEY-NR	TVH-KEY		
4	2	20	54	B	no	FS880	108TA5024	108TA4958	
4	2	22	93	E	no	B11	129TA4202	115TA5397	
4	2	26	78	BC	no	14603	141TA2654	108TA4757	
4	2	30	82	E	no	3095	129TA4021	128TA5633	
4	4	19	79	H	no			123TA5723	
4	5	34	74	E	no			141TA2986	

2.1

2A

REF [108TA4958](#)

2.1

2A

REF [115TA5397](#)

2.1

2A

REF [108TA4757](#)

2.1

2C

REF [128TA5633](#)

4.1

4B

REF [123TA5723](#)

5.4

5A

REF [141TA2986](#)

If key number is not mentioned, there is no reference on the key or the key switch is supplied with different key numbers.



KEY SWITCHES

For all our latest catalogue updates and company info: www.tvh.com

KEY SWITCHES USED FOR LINDE - LANSING

Number of connections	Number of positions	Dia (mm)	Total length (mm)	Type connection	Anti-restart	Key number	TVH-ref of key	REF switch with key	
QTY-CO	QTY-POS	D1	L1	TY-CO	AN-RE	KEY-NR	TVH-KEY		
5	2	22	56	B	no			141TA2700	
5	2	22	56	B	no	E30	108TA4994	108TA4773	
5	2	22	56	B	no	K03	108TA4996	108TA4691	
5	3	18	66	B	yes	14644	108TA5013	108TA4652	
5	3	19	55	B	no	FS883	141TA2677	128TA5827	
5	3	20	55	B	no	FS880	108TA5024	141TA3052	

2.1

2A

REF [141TA2700](#)

2.1

2A

REF [108TA4773](#)

2.1

2A

REF [108TA4691](#)

3.1

3A

REF [108TA4652](#)

3.1

3A

REF [128TA5827](#)

3.1

3A

REF [141TA3052](#)

If key number is not mentioned, there is no reference on the key or the key switch is supplied with different key numbers.

KEY SWITCHES

For all our latest catalogue updates and company info: www.tvh.com



KEY SWITCHES USED FOR LINDE - LANSING

Number of connections	Number of positions	Dia (mm)	Total length (mm)	Type connection	Anti-restart	Key number	TVH-ref of key	REF switch with key	
QTY-CO	QTY-POS	D1	L1	TY-CO	AN-RE	KEY-NR	TVH-KEY		
5	3	22	70	B	no			128TA5803	
5	4	22	59	E	yes	E30	108TA4994	110TA7900	
5	4	22	59	E	yes			108TA4755	
5	4	22	65	E	yes	E30	108TA4994	108TA4625	
5	4	25	64	E	yes			123TA5724	
6	3	26	78	BC	no	14603	141TA2654	108TA4673	

REF [128TA5803](#)

3.1

3G

REF [110TA7900](#)

4.5

4B

REF [108TA4755](#)

4.5

4B

REF [108TA4625](#)

4.3

4A

REF [123TA5724](#)

4.1

4B

REF [108TA4673](#)

3.1

3A

If key number is not mentioned, there is no reference on the key or the key switch is supplied with different key numbers.



KEY SWITCHES

For all our latest catalogue updates and company info: www.tvh.com

KEY SWITCHES USED FOR LINDE - LANSING

Number of connections	Number of positions	Dia (mm)	Total length (mm)	Type connection	Anti-restart	Key number	TVH-ref of key	REF switch with key	
QTY-CO	QTY-POS	D1	L1	TY-CO	AN-RE	KEY-NR	TVH-KEY		
6	4	16	65	BC	no	LUCAS	141TA2658	141TA2730	
6	4	19	96	E	no			141TA2852	
6	4	20	85	E	no	648	108TA5023	141TA2816	
6	4	20	86	E	no			141TA3036	
6	4	22	59	B	yes	K30	108TA5014	115TA5373	
7	3	26	78	BC	yes	14603	141TA2654	108TA4967	

4.4

4A

REF [141TA2730](#)

4.2

4B

REF [141TA2852](#)

4.2

4B

REF [141TA2816](#)

4.2

4B

REF [141TA3036](#)

4.5

4B

REF [115TA5373](#)

3.1

3A

REF [108TA4967](#)

If key number is not mentioned, there is no reference on the key or the key switch is supplied with different key numbers.

KEY SWITCHES

For all our latest catalogue updates and company info: www.tvh.com



KEY SWITCHES USED FOR LINDE - LANSING

Number of connections	Number of positions	Dia (mm)	Total length (mm)	Type connection	Anti-restart	Key number	TVH-ref of key	REF switch with key	
QTY-CO	QTY-POS	D1	L1	TY-CO	AN-RE	KEY-NR	TVH-KEY		
7	3	26	78	BC	no	14603	141TA2654	141TA2486	
7	4	16	65	BC	no	LUCAS	141TA2658	141TA2975	
7	4	22	57	B	no	14109108	108TA5008	128TA5972	
7	4	26	78	BC	no	14603	141TA2654	105TA4569	
9	4	26	78	BC	yes	14603	141TA2654	108TA4680	
9	4	26	82	BC	no	14607	110TA3492	116TA7792	

3.1

3A

REF [141TA2486](#)

4.4

4A

REF [141TA2975](#)

4.2

4H

REF [128TA5972](#)

4.1

4E

REF [105TA4569](#)

4.4

4A

REF [108TA4680](#)

4.4

4A

REF [116TA7792](#)

If key number is not mentioned, there is no reference on the key or the key switch is supplied with different key numbers.



KEY SWITCHES

For all our latest catalogue updates and company info: www.tvh.com

KEY SWITCHES USED FOR LINDE - LANSING

Number of connections	Number of positions	Dia (mm)	Total length (mm)	Type connection	Anti-restart	Key number	TVH-ref of key	REF switch with key	
QTY-CO	QTY-POS	D1	L1	TY-CO	AN-RE	KEY-NR	TVH-KEY		
10	3	22	90	BC	yes			116TA5600	
10	3	22	95	BC	yes		141TA2678	141TA3554	
10	4	26	78	BC	no	14603	141TA2654	128TA5743	
10	4	26	78	BC	yes	14603	141TA2654	128TA5768	
10	5	22	65	B	yes	K80	108TA5029	110TA7785	
10	5	26	78	BC	no	14603	141TA2654	106TA2624	

OFF
ON/ACC
START

3.1

3A

REF 116TA5600

OFF
ON/ACC
START

3.1

3G

REF 141TA3554

OFF
ON/ACC
GLOW
START
PUSH AND TURN

4.3

4A

REF 128TA5743

OFF
ON/ACC
GLOW
START

4.4

4A

REF 128TA5768

ACC
PUSH AND TURN
OFF
ON/ACC
GLOW
START
PUSH AND TURN

5.3

5F

REF 110TA7785

ACC
OFF
ON/ACC
GLOW
START

5.1

5F

REF 106TA2624

If key number is not mentioned, there is no reference on the key or the key switch is supplied with different key numbers.

KEY SWITCHES

For all our latest catalogue updates and company info: www.tvh.com



KEY SWITCHES USED FOR LINDE - LANSING

Number of connections	Number of positions	Dia (mm)	Total length (mm)	Type connection	Anti-restart	Key number	TVH-ref of key	REF switch with key	
QTY-CO	QTY-POS	D1	L1	TY-CO	AN-RE	KEY-NR	TVH-KEY		
10	5	26	78	BC	no	14603	141TA2654	141TA2848	
10	5	26	83	BC	yes	14607	110TA3492	141TA2550	
16	3	30	126	E	no	455	108TA4991	116TA7796	

5.6

5F

REF [141TA2848](#)

5.6

5F

REF [141TA2550](#)

3.2

3B

REF [116TA7796](#)

If key number is not mentioned, there is no reference on the key or the key switch is supplied with different key numbers.





KEY SWITCHES

For all our latest catalogue updates and company info: www.tvh.com

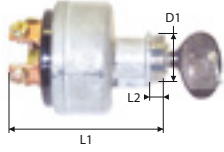
KEY SWITCHES USED FOR LOC

Number of connections	Number of positions	Dia (mm)	Total length (mm)	Type connection	Anti-restart	Key number	TVH-ref of key	REF switch with key	
QTY-CO	QTY-POS	D1	L1	TY-CO	AN-RE	KEY-NR	TVH-KEY		
2	2	15	53	H	no	601	141TA2656	110TA7651	





2.1



2A

REF [110TA7651](#)

If key number is not mentioned, there is no reference on the key or the key switch is supplied with different key numbers.

KEY SWITCHES

For all our latest catalogue updates and company info: www.tvh.com



KEY SWITCHES USED FOR LUCAS

Number of connections	Number of positions	Dia (mm)	Total length (mm)	Type connection	Anti-restart	Key number	TVH-ref of key	REF switch with key	
QTY-CO	QTY-POS	D1	L1	TY-CO	AN-RE	KEY-NR	TVH-KEY		
2	2	20	49	E	no	FS880	108TA5024	110TA7940	
3	2	20	54	B	no			109TA5967	
4	2	19	54	B	no	92274	110TA3536	141TA2534	
4	2	20	54	B	no	FFS885	108TA5028	141TA2826	
4	4	16	66	BC	no	LUCAS	141TA2658	141TA2578	
5	3	20	55	B	no	FS880	108TA5024	141TA3053	

2.1

2A

REF [110TA7940](#)

2.1

2A

REF [109TA5967](#)

2.1

2A

REF [141TA2534](#)

2.1

2A

REF [141TA2826](#)

4.8

4C

REF [141TA2578](#)

3.1

3A

REF [141TA3053](#)

If key number is not mentioned, there is no reference on the key or the key switch is supplied with different key numbers.



KEY SWITCHES

For all our latest catalogue updates and company info: www.tvh.com

KEY SWITCHES USED FOR LUCAS

Number of connections	Number of positions	Dia (mm)	Total length (mm)	Type connection	Anti-restart	Key number	TVH-ref of key	REF switch with key	
QTY-CO	QTY-POS	D1	L1	TY-CO	AN-RE	KEY-NR	TVH-KEY		
5	4	25	64	E	yes			141TA2773	
6	3	16	62	B	no	LUCAS	141TA2658	128TA5853	
6	4	16	65	BC	no	LUCAS	141TA2658	110TA7906	
6	4	20	71	BC	no			128TA5793	
7	4	16	65	BC	no	LUCAS	141TA2658	110TA7983	
7	4	20	75	BC	no	92274	110TA3536	141TA2632	

REF [141TA2773](#)

4.1

4B

REF [128TA5853](#)

3.1

3A

REF [110TA7906](#)

4.4

4A

REF [128TA5793](#)

4.4

4A

REF [110TA7983](#)

4.4

4A

REF [141TA2632](#)

4.4

4A

If key number is not mentioned, there is no reference on the key or the key switch is supplied with different key numbers.

KEY SWITCHES



For all our latest catalogue updates and company info: www.tvh.com

KEY SWITCHES USED FOR LUCAS

Number of connections	Number of positions	Dia (mm)	Total length (mm)	Type connection	Anti-restart	Key number	TVH-ref of key	REF switch with key	
QTY-CO	QTY-POS	D1	L1	TY-CO	AN-RE	KEY-NR	TVH-KEY		
7	4	30	53	B	no	92274	141TA2680	141TA2633	
10	4	26	78	BC	no	14603	141TA2654	128TA5742	

4.7

4A

REF [141TA2633](#)

4.3

4A

REF [128TA5742](#)

If key number is not mentioned, there is no reference on the key or the key switch is supplied with different key numbers.



KEY SWITCHES

For all our latest catalogue updates and company info: www.tvh.com

KEY SWITCHES USED FOR LUGLI

Number of connections	Number of positions	Dia (mm)	Total length (mm)	Type connection	Anti-restart	Key number	TVH-ref of key	REF switch with key	
QTY-CO	QTY-POS	D1	L1	TY-CO	AN-RE	KEY-NR	TVH-KEY		
6	3	22	57	B	no	E30	108TA4994	141TA2445	
6	4	16	65	BC	no	LUCAS	141TA2658	108TA4747	
7	4	16	65	BC	no	LUCAS	141TA2658	141TA2976	
7	4	20	76	BC	no	FS888	108TA5032	108TA4922	
8	4	24	55	B	no	E30	108TA4994	141TA2501	
10	5	22	90	BC	yes		110TA7916		

REF [141TA2445](#)

3.2

3B

REF [108TA4747](#)

4.4

4A

REF [141TA2976](#)

4.4

4A

REF [108TA4922](#)

4.4

4A

REF [141TA2501](#)

4.1

4E

REF [110TA7916](#)

5.8

5F

If key number is not mentioned, there is no reference on the key or the key switch is supplied with different key numbers.

KEY SWITCHES

For all our latest catalogue updates and company info: www.tvh.com



KEY SWITCHES USED FOR MANITOU

Number of connections	Number of positions	Dia (mm)	Total length (mm)	Type connection	Anti-restart	Key number	TVH-ref of key	REF switch with key	
QTY-CO	QTY-POS	D1	L1	TY-CO	AN-RE	KEY-NR	TVH-KEY		
2	2	15	53	H	no	601	141TA2656	128TA5515	
2	2	20	67	E	no			141TA2536	
3	2	19	40	G	no	002	129TA3940	141TA2836	
3	2	19	40	G	no	003	129TA3933	141TA2843	
3	3	18	78	B	yes	748	141TA2661	141TA2785	
3	3	18	80	B	yes			110TA9025	

REF [128TA5515](#)

2.1

2A

REF [141TA2536](#)

2.1

2A

REF [141TA2836](#)

2.1

2A

REF [141TA2843](#)

2.1

2A

REF [141TA2785](#)

3.1

3A

REF [110TA9025](#)

3.1

3A

If key number is not mentioned, there is no reference on the key or the key switch is supplied with different key numbers.



KEY SWITCHES

For all our latest catalogue updates and company info: www.tvh.com

KEY SWITCHES USED FOR MANITOU

Number of connections	Number of positions	Dia (mm)	Total length (mm)	Type connection	Anti-restart	Key number	TVH-ref of key	REF switch with key	
QTY-CO	QTY-POS	D1	L1	TY-CO	AN-RE	KEY-NR	TVH-KEY		
3	3	22	52	B	yes	E30 BOSCH	141TA2659	141TA2760	
3	3	25	53	E	no			118TA5757	
3	3	25	68	E	no			141TA2834	
4	2	22	62	E	no	455	129TA4161	141TA2612	
4	2	22	72	E	no	455	108TA4991	141TA2611	
4	4	18	64	B	no			141TA2933	

3.1

3A

REF [141TA2760](#)

3.1

3A

REF [118TA5757](#)

3.1

3A

REF [141TA2834](#)

2.1

2C

REF [141TA2612](#)

2.2

2A

REF [141TA2611](#)

4.2

4B

REF [141TA2933](#)

If key number is not mentioned, there is no reference on the key or the key switch is supplied with different key numbers.

KEY SWITCHES

For all our latest catalogue updates and company info: www.tvh.com



KEY SWITCHES USED FOR MANITOU

Number of connections	Number of positions	Dia (mm)	Total length (mm)	Type connection	Anti-restart	Key number	TVH-ref of key	REF switch with key		
QTY-CO	QTY-POS	D1	L1	TY-CO	AN-RE	KEY-NR	TVH-KEY			
4	4	18	74	B	no	A62597		141TA2954		
4	4	18	76	B	yes			141TA3141		
4	4	18	81	B	no			141TA2868		
4	4	18	81	B	yes			128TA5765		141TA2896
4	4	25	68	E	no					110TA9027
5	2	22	56	B	no	K03	108TA4996	141TA2888		

REF [141TA2954](#)

4.1

4B

REF [141TA3141](#)

4.2

4I

REF [141TA2868](#)

4.2

4B

REF [141TA2896](#)

4.2

4B

REF [110TA9027](#)

4.1

4B

REF [141TA2888](#)

2.1

2A

If key number is not mentioned, there is no reference on the key or the key switch is supplied with different key numbers.



KEY SWITCHES

For all our latest catalogue updates and company info: www.tvh.com

KEY SWITCHES USED FOR MANITOU

Number of connections	Number of positions	Dia (mm)	Total length (mm)	Type connection	Anti-restart	Key number	TVH-ref of key	REF switch with key	
QTY-CO	QTY-POS	D1	L1	TY-CO	AN-RE	KEY-NR	TVH-KEY		
5	2	22	56	B	no	E41	108TA4995	141TA2762	
5	2	22	56	B	no	E30	108TA4994	141TA2765	
5	4	20	69	E	no			141TA2602	
5	4	22	59	E	yes	E30	108TA4994	108TA4731	
5	4	22	65	E	yes	E30	108TA4994	110TA7668	
6	4	16	65	BC	no	LUCAS	141TA2658	110TA7981	

2.1

2A

REF [141TA2762](#)

2.1

2A

REF [141TA2765](#)

4.2

4B

REF [141TA2602](#)

4.5

4B

REF [108TA4731](#)

4.3

4A

REF [110TA7668](#)

4.4

4A

REF [110TA7981](#)

If key number is not mentioned, there is no reference on the key or the key switch is supplied with different key numbers.

KEY SWITCHES

For all our latest catalogue updates and company info: www.tvh.com



KEY SWITCHES USED FOR MANITOU

Number of connections	Number of positions	Dia (mm)	Total length (mm)	Type connection	Anti-restart	Key number	TVH-ref of key	REF switch with key	
QTY-CO	QTY-POS	D1	L1	TY-CO	AN-RE	KEY-NR	TVH-KEY		
6	4	20	96	E	no	302	129TA4032	110TA9026	
6	4	25	92	E	no	A4123	129TA4245	110TA9028	
6	5	26	61	BC	no	14610	108TA5033	108TA4898	
7	4	16	65	BC	no	LUCAS	141TA2658	110TA7982	
7	4	26	51	E	no		129TA3543	108TA4850	
10	3	22	110	E	no	455	108TA4991	141TA2595	

4.2

4B

REF [110TA9026](#)

4.2

4B

REF [110TA9028](#)

5.5

5F

REF [108TA4898](#)

4.4

4A

REF [110TA7982](#)

4.6

4G

REF [108TA4850](#)

3.2

3B

REF [141TA2595](#)

If key number is not mentioned, there is no reference on the key or the key switch is supplied with different key numbers.



KEY SWITCHES

For all our latest catalogue updates and company info: www.tvh.com

KEY SWITCHES USED FOR MANITOU

Number of connections	Number of positions	Dia (mm)	Total length (mm)	Type connection	Anti-restart	Key number	TVH-ref of key	REF switch with key	
QTY-CO	QTY-POS	D1	L1	TY-CO	AN-RE	KEY-NR	TVH-KEY		
10	5	26	78	BC	yes	14603	141TA2654	141TA2772	
10	5	26	78	BC	no	14603	141TA2654	110TA7631	
10	5	26	78	BC	no	14603	141TA2654	108TA4597	

5.6

5F

REF [141TA2772](#)

5.1

5F

REF [110TA7631](#)

5.6

5F

REF [108TA4597](#)

If key number is not mentioned, there is no reference on the key or the key switch is supplied with different key numbers.

KEY SWITCHES

For all our latest catalogue updates and company info: www.tvh.com



KEY SWITCHES USED FOR MIC

Number of connections	Number of positions	Dia (mm)	Total length (mm)	Type connection	Anti-restart	Key number	TVH-ref of key	REF switch with key	
QTY-CO	QTY-POS	D1	L1	TY-CO	AN-RE	KEY-NR	TVH-KEY		
2	2	15	53	H	no	601	141TA2656	108TA4610	
2	2	15	53	H	no	684	108TA4988	108TA4649	
3	2	22	47	B	no	702	106TA2629	110TA7538	
3	2	22	47	B	no	701	108TA4993	116TA5601	
3	2	22	48	B	no	501	106TA2631	108TA4749	
3	2	22	48	B	no	508	108TA5016	116TA7785	

2.1

2A

REF [108TA4610](#)

2.1

2A

REF [108TA4649](#)

2.1

2A

REF [110TA7538](#)

2.1

2A

REF [116TA5601](#)

2.1

2A

REF [108TA4749](#)

2.1

2A

REF [116TA7785](#)

If key number is not mentioned, there is no reference on the key or the key switch is supplied with different key numbers.



KEY SWITCHES

For all our latest catalogue updates and company info: www.tvh.com

KEY SWITCHES USED FOR MIC

Number of connections	Number of positions	Dia (mm)	Total length (mm)	Type connection	Anti-restart	Key number	TVH-ref of key	REF switch with key	
QTY-CO	QTY-POS	D1	L1	TY-CO	AN-RE	KEY-NR	TVH-KEY		
3	2	22	48,5	B	no	702	108TA4992	141TA2904	
3	2	22	49	B	no	E254	108TA5012	108TA4872	
3	2	22	49	B	no			108TA4980	
3	2	22	53	B	no	701	108TA4993	110TA7489	
3	3	18	65	B	no	14644	108TA5013	108TA4782	
4	2	20	54	B	no			108TA4816	

REF [141TA2904](#)

2.1

2A

REF [108TA4872](#)

2.1

2A

REF [108TA4980](#)

2.1

2A

REF [110TA7489](#)

2.1

2A

REF [108TA4782](#)

3.3

3A

REF [108TA4816](#)

2.1

2A

If key number is not mentioned, there is no reference on the key or the key switch is supplied with different key numbers.

KEY SWITCHES

For all our latest catalogue updates and company info: www.tvh.com



KEY SWITCHES USED FOR MIC

Number of connections	Number of positions	Dia (mm)	Total length (mm)	Type connection	Anti-restart	Key number	TVH-ref of key	REF switch with key	
QTY-CO	QTY-POS	D1	L1	TY-CO	AN-RE	KEY-NR	TVH-KEY		
4	2	22	50	B	no	738	110TA3353	123TA5709	
4	2	30	60	B	no	3A36	108TA5019	108TA4915	
4	3	20	63	B	no			108TA4717	
5	2	22	56	B	no	E30	108TA4994	141TA2766	
5	3	18	66	B	yes	14644	108TA5013	108TA4948	
6	6	22	104	BH	no	1500	108TA5020	141TA2803	

2.1

2A

REF [123TA5709](#)

2.1

2C

REF [108TA4915](#)

3.1

3A

REF [108TA4717](#)

2.1

2A

REF [141TA2766](#)

3.1

3A

REF [108TA4948](#)

6.1

6B

REF [141TA2803](#)

If key number is not mentioned, there is no reference on the key or the key switch is supplied with different key numbers.



KEY SWITCHES

For all our latest catalogue updates and company info: www.tvh.com

KEY SWITCHES USED FOR MIC

Number of connections	Number of positions	Dia (mm)	Total length (mm)	Type connection	Anti-restart	Key number	TVH-ref of key	REF switch with key	
QTY-CO	QTY-POS	D1	L1	TY-CO	AN-RE	KEY-NR	TVH-KEY		
7	3	25	62	B	yes		141TA2663	108TA4585	
10	5	22	65	B	yes	K80	108TA5029	128TA5537	
10	5	26	78	BC	no	14603	141TA2654	110TA7630	
10	5	26	78	BC	yes	14607	110TA3492	123TA5711	

REF [108TA4585](#)

3.1

3A

REF [128TA5537](#)

5.3

5F

REF [110TA7630](#)

5.1

5F

REF [123TA5711](#)

5.1

5F

If key number is not mentioned, there is no reference on the key or the key switch is supplied with different key numbers.

KEY SWITCHES

For all our latest catalogue updates and company info: www.tvh.com



KEY SWITCHES USED FOR MITSUBISHI

Number of connections	Number of positions	Dia (mm)	Total length (mm)	Type connection	Anti-restart	Key number	TVH-ref of key	REF switch with key	
QTY-CO	QTY-POS	D1	L1	TY-CO	AN-RE	KEY-NR	TVH-KEY		
2	2	15	53	H	no	601	141TA2656	141TA2938	
2	2	16	63	E	no	83357	129TA4185	141TA3086	
2	2	19	43	B	no	2007	128TA5726	141TA3079	
2	2	19	51	E	no	NG100	129TA4188	141TA3125	
2	2	19	62	B	no	CH512	118TA5814	141TA3098	
2	2	19	70	E	no	CH751	108TA5000	128TA5641	

2.1

2A

REF [141TA2938](#)

2.1

2A

REF [141TA3086](#)

2.1

2A

REF [141TA3079](#)

2.1

2A

REF [141TA3125](#)

2.1

2A

REF [141TA3098](#)

2.1

2A

REF [128TA5641](#)

If key number is not mentioned, there is no reference on the key or the key switch is supplied with different key numbers.



KEY SWITCHES

For all our latest catalogue updates and company info: www.tvh.com

KEY SWITCHES USED FOR MITSUBISHI

Number of connections	Number of positions	Dia (mm)	Total length (mm)	Type connection	Anti-restart	Key number	TVH-ref of key	REF switch with key	
QTY-CO	QTY-POS	D1	L1	TY-CO	AN-RE	KEY-NR	TVH-KEY		
2	2	20	59	E	no	CH501	122TA8962	141TA3103	
2	2	20	69	E	no	PK556	108TA5003	141TA3056	
2	2	20	71	E	no	NG100	129TA4188	141TA3130	
2	2	22	62	E	no	455	108TA4991	110TA8139	
2	3	25	55	E	no			141TA2802	
3	2	22	47	B	no	702	106TA2629	141TA3066	

2.1

2A

REF [141TA3103](#)

2.1

2A

REF [141TA3056](#)

2.1

2A

REF [141TA3130](#)

2.1

2A

REF [110TA8139](#)

3.1

3A

REF [141TA2802](#)

2.1

2A

REF [141TA3066](#)

If key number is not mentioned, there is no reference on the key or the key switch is supplied with different key numbers.

KEY SWITCHES

For all our latest catalogue updates and company info: www.tvh.com



KEY SWITCHES USED FOR MITSUBISHI

Number of connections	Number of positions	Dia (mm)	Total length (mm)	Type connection	Anti-restart	Key number	TVH-ref of key	REF switch with key	
QTY-CO	QTY-POS	D1	L1	TY-CO	AN-RE	KEY-NR	TVH-KEY		
3	2	22	48	B	no	501	106TA2631	141TA2961	
3	2	22	48	B	no	9401	122TA8945	141TA2920	
3	2	22	49	B	no	301	108TA5004	123TA5731	
3	2	22	49	B	no			141TA3039	
3	2	22	53	B	no	701	108TA4993	141TA2691	
3	2	22	55	E	no			128TA5840	

REF [141TA2961](#)

2.1

2A

REF [141TA2920](#)

2.1

2A

REF [123TA5731](#)

2.1

2A

REF [141TA3039](#)

2.1

2A

REF [141TA2691](#)

2.1

2A

REF [128TA5840](#)

2.1

2A

If key number is not mentioned, there is no reference on the key or the key switch is supplied with different key numbers.



KEY SWITCHES

For all our latest catalogue updates and company info: www.tvh.com

KEY SWITCHES USED FOR MITSUBISHI

Number of connections	Number of positions	Dia (mm)	Total length (mm)	Type connection	Anti-restart	Key number	TVH-ref of key	REF switch with key	
QTY-CO	QTY-POS	D1	L1	TY-CO	AN-RE	KEY-NR	TVH-KEY		
3	2	22	69	B	no	606	141TA2665	141TA3150	
3	3	16	59	B	no	83357	129TA4185	141TA2821	
3	3	16	61	E	no	83353	108TA4989	128TA5675	
3	3	16	65	E	no	83357	129TA4185	141TA2876	
3	3	18	78	B	yes	748	141TA2661	141TA2786	
3	3	20	63	B	no		141TA3014	141TA3014	

2.1

2A

REF [141TA3150](#)

3.1

3A

REF [141TA2821](#)

3.1

3A

REF [128TA5675](#)

3.2

3F

REF [141TA2876](#)

3.1

3A

REF [141TA2786](#)

3.1

3A

REF [141TA3014](#)

If key number is not mentioned, there is no reference on the key or the key switch is supplied with different key numbers.

KEY SWITCHES

For all our latest catalogue updates and company info: www.tvh.com



KEY SWITCHES USED FOR MITSUBISHI

Number of connections	Number of positions	Dia (mm)	Total length (mm)	Type connection	Anti-restart	Key number	TVH-ref of key	REF switch with key	
QTY-CO	QTY-POS	D1	L1	TY-CO	AN-RE	KEY-NR	TVH-KEY		
3	3	22	52	B	yes	K11	108TA5017	141TA2712	
3	3	25	56	E	no		141TA2979		
3	3	25	56	E	no	T800A	108TA5006	141TA3122	
3	3	25	56	E	no		141TA3133		
3	3	25	56	E	no	T800A	108TA5006	108TA4843	
3	3	25	57	E	no		141TA2905		

3.1

3A

REF [141TA2712](#)

3.1

3A

REF [141TA2979](#)

3.1

3A

REF [141TA3122](#)

3.1

3A

REF [141TA3133](#)

3.1

3A

REF [108TA4843](#)

3.1

3A

REF [141TA2905](#)

If key number is not mentioned, there is no reference on the key or the key switch is supplied with different key numbers.



KEY SWITCHES

For all our latest catalogue updates and company info: www.tvh.com

KEY SWITCHES USED FOR MITSUBISHI

Number of connections	Number of positions	Dia (mm)	Total length (mm)	Type connection	Anti-restart	Key number	TVH-ref of key	REF switch with key	
QTY-CO	QTY-POS	D1	L1	TY-CO	AN-RE	KEY-NR	TVH-KEY		
3	3	25	58	E	no	92274	108TA5036	141TA2752	
3	3	25	63	E	no			141TA3136	
4	2	19	54	B	no	14603	110TA3536	141TA3121	
4	2	22	65	B	no			141TA3135	
4	2	26	78	BC	no		141TA2654	141TA2965	
4	2	30	102	E	no		141TA3167		



supplied without key





3.1



3A

REF [141TA2752](#)





3.1



3A

REF [141TA3136](#)





2.1



2A

REF [141TA3121](#)





2.1



2A

REF [141TA3135](#)





2.1



2A

REF [141TA2965](#)

2.1



2A

REF [141TA3167](#)

If key number is not mentioned, there is no reference on the key or the key switch is supplied with different key numbers.

KEY SWITCHES

For all our latest catalogue updates and company info: www.tvh.com



KEY SWITCHES USED FOR MITSUBISHI

Number of connections	Number of positions	Dia (mm)	Total length (mm)	Type connection	Anti-restart	Key number	TVH-ref of key	REF switch with key	
QTY-CO	QTY-POS	D1	L1	TY-CO	AN-RE	KEY-NR	TVH-KEY		
4	3	20	63	B	no			141TA3110	
4	3	25	69,5	E	yes	D250	129TA4104	128TA5536	
4	3	25	88	B	yes		141TA2666	141TA2576	
4	4	18	64	B	no			141TA2736	
4	4	18	66	B	yes	14644	108TA5013	141TA3095	
4	4	18	74	B	no			141TA2955	

3.1

3A

REF [141TA3110](#)

3.1

3A

REF [128TA5536](#)

3.1

3A

REF [141TA2576](#)

4.2

4B

REF [141TA2736](#)

4.7

4A

REF [141TA3095](#)

4.1

4B

REF [141TA2955](#)

If key number is not mentioned, there is no reference on the key or the key switch is supplied with different key numbers.



KEY SWITCHES

For all our latest catalogue updates and company info: www.tvh.com

KEY SWITCHES USED FOR MITSUBISHI

Number of connections	Number of positions	Dia (mm)	Total length (mm)	Type connection	Anti-restart	Key number	TVH-ref of key	REF switch with key	
QTY-CO	QTY-POS	D1	L1	TY-CO	AN-RE	KEY-NR	TVH-KEY		
4	4	18	76	B	yes			141TA3142	
4	4	19	70	H	yes			141TA3073	
4	4	19	79	H	no			141TA2811	
4	4	25	62	E	yes		110TA3256	110TA7779	
5	2	22	56	B	no			128TA5529	
5	3	25	62	E	yes			128TA5505	

4.2

4I

REF [141TA3142](#)

4.1

4I

REF [141TA3073](#)

4.1

4B

REF [141TA2811](#)

4.1

4B

REF [110TA7779](#)

2.1

2A

REF [128TA5529](#)

3.1

3A

REF [128TA5505](#)

If key number is not mentioned, there is no reference on the key or the key switch is supplied with different key numbers.

KEY SWITCHES

For all our latest catalogue updates and company info: www.tvh.com



KEY SWITCHES USED FOR MITSUBISHI

Number of connections	Number of positions	Dia (mm)	Total length (mm)	Type connection	Anti-restart	Key number	TVH-ref of key	REF switch with key	
QTY-CO	QTY-POS	D1	L1	TY-CO	AN-RE	KEY-NR	TVH-KEY		
5	4	25	64	E	yes			141TA2832	
6	3	22	65	B	no	E80	108TA5005	141TA2758	
6	4	16	65	BC	no	LUCAS	141TA2658	141TA2731	
6	4	19	96	E	no			141TA2853	
6	4	20	74	E	no	001	108TA4990	141TA2950	
6	4	20	74	E	no	001	108TA4990	141TA2970	

4.1

4B

REF [141TA2832](#)

3.1

3A

REF [141TA2758](#)

4.4

4A

REF [141TA2731](#)

4.2

4B

REF [141TA2853](#)

4.2

4B

REF [141TA2950](#)

4.2

4B

REF [141TA2970](#)

If key number is not mentioned, there is no reference on the key or the key switch is supplied with different key numbers.



KEY SWITCHES

For all our latest catalogue updates and company info: www.tvh.com

KEY SWITCHES USED FOR MITSUBISHI

Number of connections	Number of positions	Dia (mm)	Total length (mm)	Type connection	Anti-restart	Key number	TVH-ref of key	REF switch with key	
QTY-CO	QTY-POS	D1	L1	TY-CO	AN-RE	KEY-NR	TVH-KEY		
6	4	20	74	E	no	001	108TA4990	141TA2992	
6	4	20	86	E	no	777EXPORT	115TA5483	141TA2827	
6	4	20	86	E	no			141TA3037	
6	4	25	76	E	no			110TA7726	
6	4	25	78	E	no			110TA7843	
6	4	25	79	E	yes		123243	108TA5035	

REF [141TA2992](#)

4.2

4B

REF [141TA2827](#)

4.2

4B

REF [141TA3037](#)

4.2

4B

REF [110TA7726](#)

4.2

4B

REF [110TA7843](#)

4.2

4B

REF [128TA5754](#)

4.2

4B

If key number is not mentioned, there is no reference on the key or the key switch is supplied with different key numbers.

KEY SWITCHES

For all our latest catalogue updates and company info: www.tvh.com



KEY SWITCHES USED FOR MITSUBISHI

Number of connections	Number of positions	Dia (mm)	Total length (mm)	Type connection	Anti-restart	Key number	TVH-ref of key	REF switch with key	
QTY-CO	QTY-POS	D1	L1	TY-CO	AN-RE	KEY-NR	TVH-KEY		
6	4	28	95	E	no	5154	129TA4124	141TA2754	
6	6	22	104	BH	no	1500	108TA5020	141TA2804	
7	3	25	62	B	yes		129TA3664	141TA2924	
7	3	25	62	B	yes		141TA2663	141TA2721	
7	3	26	78	BC	yes	14603	141TA2654	141TA3033	
10	3	22	90	BC	yes		141TA2841	141TA2841	

4.2

4B

REF [141TA2754](#)

6.1

6B

REF [141TA2804](#)

3.1

3A

REF [141TA2924](#)

3.1

3A

REF [141TA2721](#)

3.1

3A

REF [141TA3033](#)

3.1

3A

REF [141TA2841](#)

If key number is not mentioned, there is no reference on the key or the key switch is supplied with different key numbers.



KEY SWITCHES

For all our latest catalogue updates and company info: www.tvh.com

KEY SWITCHES USED FOR MITSUBISHI

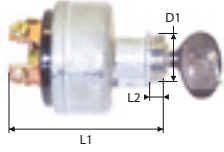
Number of connections	Number of positions	Dia (mm)	Total length (mm)	Type connection	Anti-restart	Key number	TVH-ref of key	REF switch with key	
QTY-CO	QTY-POS	D1	L1	TY-CO	AN-RE	KEY-NR	TVH-KEY		
10	5	26	78	BC	yes	14607	110TA3492	141TA3077	





5.1



5F

REF [141TA3077](#)

If key number is not mentioned, there is no reference on the key or the key switch is supplied with different key numbers.

KEY SWITCHES

For all our latest catalogue updates and company info: www.tvh.com

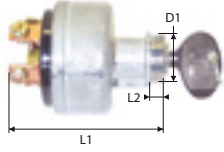

KEY SWITCHES USED FOR MORA

Number of connections	Number of positions	Dia (mm)	Total length (mm)	Type connection	Anti-restart	Key number	TVH-ref of key	REF switch with key	
QTY-CO	QTY-POS	D1	L1	TY-CO	AN-RE	KEY-NR	TVH-KEY		
7	4	16	65	BC	no	LUCAS	141TA2658	108TA4805	



REF [108TA4805](#)



4.4



4A

If key number is not mentioned, there is no reference on the key or the key switch is supplied with different key numbers.



KEY SWITCHES

For all our latest catalogue updates and company info: www.tvh.com

KEY SWITCHES USED FOR NISSAN

Number of connections	Number of positions	Dia (mm)	Total length (mm)	Type connection	Anti-restart	Key number	TVH-ref of key	REF switch with key	
QTY-CO	QTY-POS	D1	L1	TY-CO	AN-RE	KEY-NR	TVH-KEY		
2	2	19	62	B	no	CH512	118TA5814	141TA3099	
2	2	22	57	E	no			141TA2984	
2	2	22	67	E	no	KN101	110TA3541	128TA5581	
3	2	22	49	B	no	301	108TA5004	141TA2983	
3	3	16	65	E	no	83357	129TA4185	141TA2878	
3	3	18	65	B	no	14644	108TA5013	141TA2791	

2.1

2A

REF [141TA3099](#)

2.1

2A

REF [141TA2984](#)

2.1

2A

REF [128TA5581](#)

2.1

2A

REF [141TA2983](#)

3.2

3F

REF [141TA2878](#)

3.3

3A

REF [141TA2791](#)

If key number is not mentioned, there is no reference on the key or the key switch is supplied with different key numbers.

KEY SWITCHES

For all our latest catalogue updates and company info: www.tvh.com



KEY SWITCHES USED FOR NISSAN

Number of connections	Number of positions	Dia (mm)	Total length (mm)	Type connection	Anti-restart	Key number	TVH-ref of key	REF switch with key	
QTY-CO	QTY-POS	D1	L1	TY-CO	AN-RE	KEY-NR	TVH-KEY		
3	3	20	63	B	no	N1417	110TA3435	110TA7414	
3	3	20	63	B	no			110TA8215	
3	3	20	81	E	no			108TA4792	
4	3	20	63	B	yes			110TA7769	
4	3	20	63	B	no			110TA7768	
4	3	20	63	B	no			141TA2561	

3.1

3A

REF [110TA7414](#)

3.1

3A

REF [110TA8215](#)

3.1

3A

REF [108TA4792](#)

3.1

3A

REF [110TA7769](#)

3.1

3A

REF [110TA7768](#)

3.1

3A

REF [141TA2561](#)

If key number is not mentioned, there is no reference on the key or the key switch is supplied with different key numbers.



KEY SWITCHES

For all our latest catalogue updates and company info: www.tvh.com

KEY SWITCHES USED FOR NISSAN

Number of connections	Number of positions	Dia (mm)	Total length (mm)	Type connection	Anti-restart	Key number	TVH-ref of key	REF switch with key	
QTY-CO	QTY-POS	D1	L1	TY-CO	AN-RE	KEY-NR	TVH-KEY		
4	3	20	69	B	no			141TA2585	
4	3	20	70	B	no			141TA2520	
4	3	20	70	B	no	B5160	141TA2681	141TA2526	
4	3	20	70	B	yes	B5160	141TA2681	141TA2537	
4	4	18	70	B	no			138TA9118	
4	4	18	74	B	no			141TA2956	

OFF
ON/ACC
START

3.1

3A

REF [141TA2585](#)

OFF
ON/ACC
START

3.1

3A

REF [141TA2520](#)

OFF
ON/ACC
START

3.1

3A

REF [141TA2526](#)

OFF
ON/ACC
START

3.1

3A

REF [141TA2537](#)

GLOW OFF ON/ACC
START

4.2

4B

REF [138TA9118](#)

ACC OFF ON/ACC
START

4.1

4B

REF [141TA2956](#)

If key number is not mentioned, there is no reference on the key or the key switch is supplied with different key numbers.

KEY SWITCHES

For all our latest catalogue updates and company info: www.tvh.com

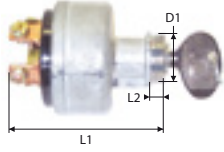

KEY SWITCHES USED FOR NISSAN

Number of connections	Number of positions	Dia (mm)	Total length (mm)	Type connection	Anti-restart	Key number	TVH-ref of key	REF switch with key		
QTY-CO	QTY-POS	D1	L1	TY-CO	AN-RE	KEY-NR	TVH-KEY			
5	4	20	64	B	no	E80 777EXPORT	108TA5005	141TA2453		
5	4	25	64	E	yes			128TA5504		
6	3	22	65	B	no			128TA5541		
6	4	20	85	E	no			108TA4879		
6	4	20	86	E	no			115TA5483		141TA2828
6	4	20	86	E	no					108TA4969



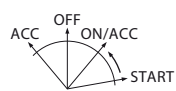



4.1



4B

REF [141TA2453](#)







4.1



4B

REF [128TA5504](#)





3.1



3A

REF [128TA5541](#)



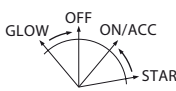

4.2



4B

REF [108TA4879](#)



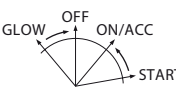

4.2



4B

REF [141TA2828](#)



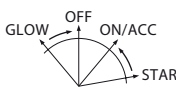

4.2



4B

REF [108TA4969](#)

If key number is not mentioned, there is no reference on the key or the key switch is supplied with different key numbers.



KEY SWITCHES

For all our latest catalogue updates and company info: www.tvh.com

KEY SWITCHES USED FOR NISSAN

Number of connections	Number of positions	Dia (mm)	Total length (mm)	Type connection	Anti-restart	Key number	TVH-ref of key	REF switch with key	
QTY-CO	QTY-POS	D1	L1	TY-CO	AN-RE	KEY-NR	TVH-KEY		
6	4	25	78	E	no			<u>115TA5363</u>	
6	4	25	79	E	yes	123243	<u>108TA5035</u>	<u>141TA2918</u>	
7	3	25	62	B	yes		<u>129TA3664</u>	<u>128TA5500</u>	
7	3	25	67	B	yes			<u>128TA5673</u>	

4.2

4B

REF 115TA5363

4.2

4B

REF 141TA2918

3.1

3A

REF 128TA5500

3.1

3G

REF 128TA5673

If key number is not mentioned, there is no reference on the key or the key switch is supplied with different key numbers.

KEY SWITCHES

For all our latest catalogue updates and company info: www.tvh.com



KEY SWITCHES USED FOR NYK - NICHYU

Number of connections	Number of positions	Dia (mm)	Total length (mm)	Type connection	Anti-restart	Key number	TVH-ref of key	REF switch with key	
QTY-CO	QTY-POS	D1	L1	TY-CO	AN-RE	KEY-NR	TVH-KEY		
2	2	24	40	G	no	5541	141TA2668	110TA8129	
3	3	25	56	E	no			108TA4839	
3	3	25	56	E	no	T800A	108TA5006	141TA3123	
3	3	25	56	E	no			141TA2544	
3	3	25	56	E	no	T800A	108TA5006	110TA8128	
3	3	25	56	E	no	T800A	108TA5006	110TA8130	

REF [110TA8129](#)

2.1

2A

REF [108TA4839](#)

3.1

3A

REF [141TA3123](#)

3.1

3A

REF [141TA2544](#)

3.1

3A

REF [110TA8128](#)

3.1

3A

REF [110TA8130](#)

3.1

3A

If key number is not mentioned, there is no reference on the key or the key switch is supplied with different key numbers.



KEY SWITCHES

For all our latest catalogue updates and company info: www.tvh.com

KEY SWITCHES USED FOR NYK - NICHYU

Number of connections	Number of positions	Dia (mm)	Total length (mm)	Type connection	Anti-restart	Key number	TVH-ref of key	REF switch with key	
QTY-CO	QTY-POS	D1	L1	TY-CO	AN-RE	KEY-NR	TVH-KEY		
3	3	25	57	E	no			128TA5995	
3	3	25	58	E	no		108TA5036	108TA4957	
3	3	25	63	E	no			141TA2554	
4	2	30	102	E	no			141TA2613	

type of plug

3.1

3A

REF [128TA5995](#)

supplied without key

3.1

3A

REF [108TA4957](#)

3.1

3A

REF [141TA2554](#)

2.1

2A

REF [141TA2613](#)

If key number is not mentioned, there is no reference on the key or the key switch is supplied with different key numbers.

KEY SWITCHES

For all our latest catalogue updates and company info: www.tvh.com



KEY SWITCHES USED FOR OMG

Number of connections	Number of positions	Dia (mm)	Total length (mm)	Type connection	Anti-restart	Key number	TVH-ref of key	REF switch with key	
QTY-CO	QTY-POS	D1	L1	TY-CO	AN-RE	KEY-NR	TVH-KEY		
2	2	19	52	G	no	9471	141TA2657	128TA5748	
2	2	25	61	E	no	701 TCM	128TA5735	141TA2857	
3	2	22	44	B	no			108TA4877	
4	2	19	37	G	no			141TA2915	
4	2	22	53	B	no	E30	108TA4994	128TA5702	
4	2	25	61	E	no	701 TCM	128TA5735	141TA2859	

REF [128TA5748](#)

2.1

2C

REF [141TA2857](#)

2.1

2A

REF [108TA4877](#)

2.1

2A

REF [141TA2915](#)

2.1

2A

REF [128TA5702](#)

2.1

2A

REF [141TA2859](#)

2.1

2A

If key number is not mentioned, there is no reference on the key or the key switch is supplied with different key numbers.





KEY SWITCHES

For all our latest catalogue updates and company info: www.tvh.com

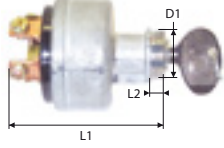
KEY SWITCHES USED FOR OMG

Number of connections	Number of positions	Dia (mm)	Total length (mm)	Type connection	Anti-restart	Key number	TVH-ref of key	REF switch with key	
QTY-CO	QTY-POS	D1	L1	TY-CO	AN-RE	KEY-NR	TVH-KEY		
4	3	20	63	B	no			128TA5667	





3.1



3A

REF [128TA5667](#)

If key number is not mentioned, there is no reference on the key or the key switch is supplied with different key numbers.

KEY SWITCHES

For all our latest catalogue updates and company info: www.tvh.com



KEY SWITCHES USED FOR PRAMAC

Number of connections	Number of positions	Dia (mm)	Total length (mm)	Type connection	Anti-restart	Key number	TVH-ref of key	REF switch with key	
QTY-CO	QTY-POS	D1	L1	TY-CO	AN-RE	KEY-NR	TVH-KEY		
2	2	19	48	G	no			110TA8167	
3	3	25	67	F	no			141TA2600	

type of plug

2.1

REF [110TA8167](#)

2A

3.1

REF [141TA2600](#)

3A

If key number is not mentioned, there is no reference on the key or the key switch is supplied with different key numbers.



KEY SWITCHES

For all our latest catalogue updates and company info: www.tvh.com

KEY SWITCHES USED FOR PRAT

Number of connections	Number of positions	Dia (mm)	Total length (mm)	Type connection	Anti-restart	Key number	TVH-ref of key	REF switch with key	
QTY-CO	QTY-POS	D1	L1	TY-CO	AN-RE	KEY-NR	TVH-KEY		
2	2	15	53	H	no	601	141TA2656	115TA5361	
2	2	15	53	H	no	684	108TA4988	108TA4653	
2	2	22	61	E	no	455	108TA4991	141TA2472	
2	2	22	62	E	no	455	108TA4991	123TA5734	
4	5	34	74	E	no			123TA5735	
5	2	22	56	B	no			123TA5736	

REF [115TA5361](#)

2.1

2A

REF [108TA4653](#)

2.1

2A

REF [141TA2472](#)

2.1

2C

REF [123TA5734](#)

2.1

2A

REF [123TA5735](#)

Type of plug

5.4

5A

REF [123TA5736](#)

2.1

2A

If key number is not mentioned, there is no reference on the key or the key switch is supplied with different key numbers.

KEY SWITCHES



For all our latest catalogue updates and company info: www.tvh.com

KEY SWITCHES USED FOR SANDERSON

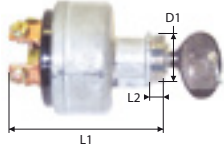
Number of connections	Number of positions	Dia (mm)	Total length (mm)	Type connection	Anti-restart	Key number	TVH-ref of key	REF switch with key	
QTY-CO	QTY-POS	D1	L1	TY-CO	AN-RE	KEY-NR	TVH-KEY		
9	4	20	75	BC	no			108TA4920	



REF [108TA4920](#)

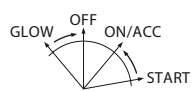

4.2



4B

If key number is not mentioned, there is no reference on the key or the key switch is supplied with different key numbers.



KEY SWITCHES

For all our latest catalogue updates and company info: www.tvh.com

KEY SWITCHES USED FOR SHINKO

Number of connections	Number of positions	Dia (mm)	Total length (mm)	Type connection	Anti-restart	Key number	TVH-ref of key	REF switch with key	
QTY-CO	QTY-POS	D1	L1	TY-CO	AN-RE	KEY-NR	TVH-KEY		
3	3	24	56	G	no			128TA5814	
4	3	24	40	G	no			128TA5788	
4	4	18	74	B	no			141TA2957	
8	3	24	41	D	no			108TA4923	

type of plug

3.3

3A

REF [128TA5814](#)

type of plug

3.3

3A

REF [128TA5788](#)

4.1

4B

REF [141TA2957](#)

3.3

3A

REF [108TA4923](#)

If key number is not mentioned, there is no reference on the key or the key switch is supplied with different key numbers.

KEY SWITCHES

For all our latest catalogue updates and company info: www.tvh.com



KEY SWITCHES USED FOR SICHELSMIDT

Number of connections	Number of positions	Dia (mm)	Total length (mm)	Type connection	Anti-restart	Key number	TVH-ref of key	REF switch with key	
QTY-CO	QTY-POS	D1	L1	TY-CO	AN-RE	KEY-NR	TVH-KEY		
5	2	22	56	B	no			108TA4666	
5	2	22	56	B	no	K03	108TA4996	128TA5786	





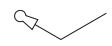

2.1



2A

REF [108TA4666](#)





2.1

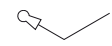

2A

REF [128TA5786](#)

If key number is not mentioned, there is no reference on the key or the key switch is supplied with different key numbers.



KEY SWITCHES

For all our latest catalogue updates and company info: www.tvh.com

KEY SWITCHES USED FOR STEINBOCK - BOSS

Number of connections	Number of positions	Dia (mm)	Total length (mm)	Type connection	Anti-restart	Key number	TVH-ref of key	REF switch with key	
QTY-CO	QTY-POS	D1	L1	TY-CO	AN-RE	KEY-NR	TVH-KEY		
2	2	15	53	H	no	601	141TA2656	108TA4612	
3	2	22	47	B	no	702	106TA2629	108TA4590	
3	2	22	47	E	no	P27	141TA2676	141TA2496	
3	2	22	47	B	no	701	108TA4993	116TA5602	
3	2	22	48	B	no	501	106TA2631	110TA7917	
3	2	22	48	B	no	508	108TA5016	141TA3005	

REF [108TA4612](#)

2.1

2A

REF [108TA4590](#)

2.1

2A

REF [141TA2496](#)

2.1

2A

REF [116TA5602](#)

2.1

2A

REF [110TA7917](#)

2.1

2A

REF [141TA3005](#)

2.1

2A

If key number is not mentioned, there is no reference on the key or the key switch is supplied with different key numbers.

KEY SWITCHES

For all our latest catalogue updates and company info: www.tvh.com



KEY SWITCHES USED FOR STEINBOCK - BOSS

Number of connections	Number of positions	Dia (mm)	Total length (mm)	Type connection	Anti-restart	Key number	TVH-ref of key	REF switch with key	
QTY-CO	QTY-POS	D1	L1	TY-CO	AN-RE	KEY-NR	TVH-KEY		
3	2	22	49	B	no	E254	108TA5012	110TA8150	
3	2	22	49	B	no		108TA4981	108TA4981	
3	2	22	53	B	no	701	108TA4993	141TA2692	
3	3	18	65	B	no	14644	108TA5013	141TA2792	
3	3	22	52	B	yes		108TA4638	108TA4638	
4	2	20	54	B	no		108TA4817	108TA4817	

REF [110TA8150](#)

2.1

2A

REF [108TA4981](#)

2.1

2A

REF [141TA2692](#)

2.1

2A

REF [141TA2792](#)

3.3

3A

REF [108TA4638](#)

3.1

3A

REF [108TA4817](#)

2.1

2A

If key number is not mentioned, there is no reference on the key or the key switch is supplied with different key numbers.



KEY SWITCHES

For all our latest catalogue updates and company info: www.tvh.com

KEY SWITCHES USED FOR STEINBOCK - BOSS

Number of connections	Number of positions	Dia (mm)	Total length (mm)	Type connection	Anti-restart	Key number	TVH-ref of key	REF switch with key	
QTY-CO	QTY-POS	D1	L1	TY-CO	AN-RE	KEY-NR	TVH-KEY		
4	2	22	50	B	no	738	110TA3353	141TA2820	
4	2	30	80	E	no	3095	122TA8983	141TA3147	
4	4	18	66	B	yes	14644	108TA5013	141TA3096	
5	2	22	56	B	no	E30	108TA4994	141TA2767	
5	2	22	56	B	no	K03	108TA4996	141TA2889	
5	4	22	59	E	yes	E30	108TA4994	116TA7772	

REF [141TA2820](#)

2.1

2A

REF [141TA3147](#)

2.1

2A

REF [141TA3096](#)

4.7

4A

REF [141TA2767](#)

2.1

2A

REF [141TA2889](#)

2.1

2A

REF [116TA7772](#)

4.5

4B

If key number is not mentioned, there is no reference on the key or the key switch is supplied with different key numbers.

KEY SWITCHES

For all our latest catalogue updates and company info: www.tvh.com



KEY SWITCHES USED FOR STEINBOCK - BOSS

Number of connections	Number of positions	Dia (mm)	Total length (mm)	Type connection	Anti-restart	Key number	TVH-ref of key	REF switch with key	
QTY-CO	QTY-POS	D1	L1	TY-CO	AN-RE	KEY-NR	TVH-KEY		
5	4	22	65	E	yes	E30	108TA4994	123TA5710	
6	2	24	89	E	no	8R1	129TA4223	110TA8146	
6	4	16	65	BC	no	LUCAS	141TA2658	108TA4740	
6	4	20	74	E	no	001	108TA4990	108TA4760	
7	4	20	76	BC	no	FS888	108TA5032	141TA2747	
10	5	22	65	B	yes	K80	108TA5029	141TA2717	

REF [123TA5710](#)

4.3

4A

REF [110TA8146](#)

2.1

2A

REF [108TA4740](#)

4.4

4A

REF [108TA4760](#)

4.2

4B

REF [141TA2747](#)

4.4

4A

REF [141TA2717](#)

5.3

5F

If key number is not mentioned, there is no reference on the key or the key switch is supplied with different key numbers.



KEY SWITCHES

For all our latest catalogue updates and company info: www.tvh.com

KEY SWITCHES USED FOR STEINBOCK - BOSS

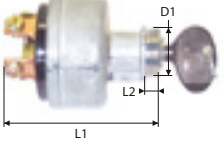
Number of connections	Number of positions	Dia (mm)	Total length (mm)	Type connection	Anti-restart	Key number	TVH-ref of key	REF switch with key	
QTY-CO	QTY-POS	D1	L1	TY-CO	AN-RE	KEY-NR	TVH-KEY		
10	5	26	78	BC	no	14603	141TA2654	108TA4598	



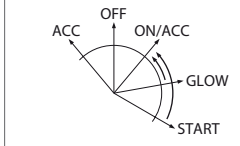

5.1

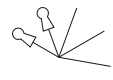

5F

REF [108TA4598](#)

If key number is not mentioned, there is no reference on the key or the key switch is supplied with different key numbers.

KEY SWITCHES

For all our latest catalogue updates and company info: www.tvh.com



KEY SWITCHES USED FOR STILL

Number of connections	Number of positions	Dia (mm)	Total length (mm)	Type connection	Anti-restart	Key number	TVH-ref of key	REF switch with key	
QTY-CO	QTY-POS	D1	L1	TY-CO	AN-RE	KEY-NR	TVH-KEY		
2	2	15	53	H	no	601	141TA2656	108TA4608	
2	2	15	53	H	no	684	108TA4988	110TA7743	
2	2	16	48	B	no	633	108TA5011	141TA2698	
2	2	18	74	H	no			110TA8217	
2	2	20	49	E	no	FS880	108TA5024	108TA4776	
2	2	22	50	B	no			123TA5738	

2.1

2A

REF [108TA4608](#)

2.1

2A

REF [110TA7743](#)

2.1

2A

REF [141TA2698](#)

2.1

2A

REF [110TA8217](#)

2.1

2A

REF [108TA4776](#)

2.1

2A

REF [123TA5738](#)

If key number is not mentioned, there is no reference on the key or the key switch is supplied with different key numbers.



KEY SWITCHES

For all our latest catalogue updates and company info: www.tvh.com

KEY SWITCHES USED FOR STILL

Number of connections	Number of positions	Dia (mm)	Total length (mm)	Type connection	Anti-restart	Key number	TVH-ref of key	REF switch with key	
QTY-CO	QTY-POS	D1	L1	TY-CO	AN-RE	KEY-NR	TVH-KEY		
2	2	22	62	E	no	455	108TA4991	108TA4853	
3	2	22	44	B	no			141TA3117	
3	2	22	48	B	no	530	106TA2637	110TA7790	
3	2	22	48	B	no	501	106TA2631	115TA5370	
3	2	22	49	B	no	503	106TA2635	110TA7674	
3	2	22	49	B	no	802	108TA5030	141TA3019	

2.1

2A

REF [108TA4853](#)

2.1

2A

REF [141TA3117](#)

2.1

2A

REF [110TA7790](#)

2.1

2A

REF [115TA5370](#)

2.1

2A

REF [110TA7674](#)

2.1

2A

REF [141TA3019](#)

If key number is not mentioned, there is no reference on the key or the key switch is supplied with different key numbers.

KEY SWITCHES

For all our latest catalogue updates and company info: www.tvh.com



KEY SWITCHES USED FOR STILL

Number of connections	Number of positions	Dia (mm)	Total length (mm)	Type connection	Anti-restart	Key number	TVH-ref of key	REF switch with key	
QTY-CO	QTY-POS	D1	L1	TY-CO	AN-RE	KEY-NR	TVH-KEY		
3	3	22	46	B	no	K11		123TA5739	
3	3	22	48	B	no			128TA5790	
3	3	22	52	B	yes			108TA4636	
3	3	22	52	B	yes		108TA5017	110TA7834	
3	3	22	52	B	no		108TA5026	141TA2849	
4	2	20	54	B	no			108TA4815	

3.2

3D

REF [123TA5739](#)

3.3

3A

REF [128TA5790](#)

3.1

3A

REF [108TA4636](#)

3.1

3A

REF [110TA7834](#)

3.1

3A

REF [141TA2849](#)

2.1

2A

REF [108TA4815](#)

If key number is not mentioned, there is no reference on the key or the key switch is supplied with different key numbers.



KEY SWITCHES

For all our latest catalogue updates and company info: www.tvh.com

KEY SWITCHES USED FOR STILL

Number of connections	Number of positions	Dia (mm)	Total length (mm)	Type connection	Anti-restart	Key number	TVH-ref of key	REF switch with key	
QTY-CO	QTY-POS	D1	L1	TY-CO	AN-RE	KEY-NR	TVH-KEY		
4	2	22	93	E	no	B11	129TA4202	115TA5395	
4	3	20	63	B	no			141TA3111	
4	5	34	74	E	no			108TA4861	
5	2	22	56	B	no			108TA4660	
5	2	22	56	B	no	E30	108TA4994	108TA4770	
5	2	22	56	B	no	K03	108TA4996	141TA2890	

2.1

2A

REF [115TA5395](#)

3.1

3A

REF [141TA3111](#)

5.4

5A

REF [108TA4861](#)

2.1

2A

REF [108TA4660](#)

2.1

2A

REF [108TA4770](#)

2.1

2A

REF [141TA2890](#)

If key number is not mentioned, there is no reference on the key or the key switch is supplied with different key numbers.

KEY SWITCHES

For all our latest catalogue updates and company info: www.tvh.com



KEY SWITCHES USED FOR STILL

Number of connections	Number of positions	Dia (mm)	Total length (mm)	Type connection	Anti-restart	Key number	TVH-ref of key	REF switch with key	
QTY-CO	QTY-POS	D1	L1	TY-CO	AN-RE	KEY-NR	TVH-KEY		
5	3	20	55	B	no	FS880	108TA5024	141TA3054	
5	4	22	59	E	yes	E30	108TA4994	108TA4728	
5	4	22	59	E	yes			108TA4752	
5	4	22	65	E	yes	E30	108TA4994	110TA7663	
6	3	22	65	B	no	E80	108TA5005	108TA4679	
6	4	16	65	BC	no	LUCAS	141TA2658	108TA4738	

3.1

3A

REF [141TA3054](#)

4.5

4B

REF [108TA4728](#)

4.5

4B

REF [108TA4752](#)

4.3

4A

REF [110TA7663](#)

3.1

3A

REF [108TA4679](#)

4.4

4A

REF [108TA4738](#)

If key number is not mentioned, there is no reference on the key or the key switch is supplied with different key numbers.



KEY SWITCHES

For all our latest catalogue updates and company info: www.tvh.com

KEY SWITCHES USED FOR STILL

Number of connections	Number of positions	Dia (mm)	Total length (mm)	Type connection	Anti-restart	Key number	TVH-ref of key	REF switch with key	
QTY-CO	QTY-POS	D1	L1	TY-CO	AN-RE	KEY-NR	TVH-KEY		
6	4	22	55	B	yes	K10	141TA2660	141TA3055	
10	5	22	65	B	yes	K80	108TA5029	108TA4676	
10	5	26	78	BC	no	14603	141TA2654	108TA4595	

4.5

4B

REF [141TA3055](#)

5.3

5F

REF [108TA4676](#)

5.1

5F

REF [108TA4595](#)

If key number is not mentioned, there is no reference on the key or the key switch is supplied with different key numbers.

KEY SWITCHES

For all our latest catalogue updates and company info: www.tvh.com



KEY SWITCHES USED FOR SVE TRUCK

Number of connections	Number of positions	Dia (mm)	Total length (mm)	Type connection	Anti-restart	Key number	TVH-ref of key	REF switch with key	
QTY-CO	QTY-POS	D1	L1	TY-CO	AN-RE	KEY-NR	TVH-KEY		
4	2	19	49	G	no	93201	<u>108TA5027</u>	<u>141TA3030</u>	
4	3	19	55	B	no			<u>141TA2744</u>	
5	2	22	56	B	no			<u>141TA2701</u>	
6	4	22	59	B	yes			<u>108TA4786</u>	
6	5	32	83	B	no			<u>141TA2838</u>	
10	5	22	65	B	yes			<u>141TA2714</u>	

2.2

2A

REF 141TA3030

3.2

3B

REF 141TA2744

2.1

2A

REF 141TA2701

4.5

4B

REF 108TA4786

5.2

5B

REF 141TA2838

5.3

5F

REF 141TA2714

If key number is not mentioned, there is no reference on the key or the key switch is supplied with different key numbers.



KEY SWITCHES

For all our latest catalogue updates and company info: www.tvh.com

KEY SWITCHES USED FOR TCM

Number of connections	Number of positions	Dia (mm)	Total length (mm)	Type connection	Anti-restart	Key number	TVH-ref of key	REF switch with key	
QTY-CO	QTY-POS	D1	L1	TY-CO	AN-RE	KEY-NR	TVH-KEY		
2	2	15	53	H	no	601	141TA2656	108TA4607	
2	2	25	61	E	no	701 TCM	128TA5735	128TA5734	
2	2	25	68	E	no	511	110TA3478	108TA4866	
3	3	16	65	E	no	83357	129TA4185	141TA2879	
3	3	18	78	B	yes	748	141TA2661	141TA2787	
3	3	20	63	B	no		141TA3015		

2.1

2A

REF [108TA4607](#)

2.1

2A

REF [128TA5734](#)

2.1

2A

REF [108TA4866](#)

3.2

3F

REF [141TA2879](#)

3.1

3A

REF [141TA2787](#)

3.1

3A

REF [141TA3015](#)

If key number is not mentioned, there is no reference on the key or the key switch is supplied with different key numbers.

KEY SWITCHES

For all our latest catalogue updates and company info: www.tvh.com



KEY SWITCHES USED FOR TCM

Number of connections	Number of positions	Dia (mm)	Total length (mm)	Type connection	Anti-restart	Key number	TVH-ref of key	REF switch with key	
QTY-CO	QTY-POS	D1	L1	TY-CO	AN-RE	KEY-NR	TVH-KEY		
3	3	20	81	E	no			110TA7964	
3	3	25	56	E	no			141TA2980	
3	3	25	58	E	no			141TA2452	
4	2	19	54	G	no			128TA5994	
4	2	25	61	E	no	701 TCM	128TA5735	128TA5744	
4	2	25	68	E	no	511	110TA3478	110TA8137	

3.1

3A

REF [110TA7964](#)

3.1

3A

REF [141TA2980](#)

3.1

3A

REF [141TA2452](#)

2.1

2C

REF [128TA5994](#)

2.1

2A

REF [128TA5744](#)

2.1

2A

REF [110TA8137](#)

If key number is not mentioned, there is no reference on the key or the key switch is supplied with different key numbers.



KEY SWITCHES

For all our latest catalogue updates and company info: www.tvh.com

KEY SWITCHES USED FOR TCM

Number of connections	Number of positions	Dia (mm)	Total length (mm)	Type connection	Anti-restart	Key number	TVH-ref of key	REF switch with key	
QTY-CO	QTY-POS	D1	L1	TY-CO	AN-RE	KEY-NR	TVH-KEY		
4	3	20	63	B	yes			141TA3047	
4	3	20	63	B	no			141TA3112	
4	4	18	64	B	no			108TA4766	
4	4	19	79	H	no			108TA4828	
6	4	19	96	E	no			110TA7436	
6	4	20	81	E	no			141TA2543	

3.1

3A

REF [141TA3047](#)

3.1

3A

REF [141TA3112](#)

4.2

4B

REF [108TA4766](#)

4.1

4B

REF [108TA4828](#)

4.2

4B

REF [110TA7436](#)

4.2

4B

REF [141TA2543](#)

If key number is not mentioned, there is no reference on the key or the key switch is supplied with different key numbers.

KEY SWITCHES

For all our latest catalogue updates and company info: www.tvh.com



KEY SWITCHES USED FOR TCM

Number of connections	Number of positions	Dia (mm)	Total length (mm)	Type connection	Anti-restart	Key number	TVH-ref of key	REF switch with key	
QTY-CO	QTY-POS	D1	L1	TY-CO	AN-RE	KEY-NR	TVH-KEY		
6	4	20	82	E	no		108TA5015	110TA7928	
6	4	20	86	E	no			110TA8256	
6	4	20	89	E	no			128TA5976	
7	3	25	62	B	yes		129TA3664	141TA2925	
8	4	20	86	BE	no			108TA4897	
10	5	26	78	BC	no	14603	141TA2654	128TA5507	

4.2

4B

REF [110TA7928](#)

4.2

4B

REF [110TA8256](#)

4.2

4B

REF [128TA5976](#)

3.1

3A

REF [141TA2925](#)

4.2

4B

REF [108TA4897](#)

5.1

5F

REF [128TA5507](#)

If key number is not mentioned, there is no reference on the key or the key switch is supplied with different key numbers.



KEY SWITCHES

For all our latest catalogue updates and company info: www.tvh.com

KEY SWITCHES USED FOR TOYOTA

Number of connections	Number of positions	Dia (mm)	Total length (mm)	Type connection	Anti-restart	Key number	TVH-ref of key	REF switch with key	
QTY-CO	QTY-POS	D1	L1	TY-CO	AN-RE	KEY-NR	TVH-KEY		
2	2	16	63	E	no	83357	129TA4185	141TA3087	
2	2	19	43	B	no	2007	128TA5726	141TA3173	
2	2	19	62	B	no	CH512	118TA5814	141TA3100	
2	2	19	70	E	no	CH751	108TA5000	141TA2770	
2	2	20	59	E	no	CH501	122TA8962	141TA3104	
2	2	20	71	E	no	NG100	129TA4188	141TA3131	

With NO-contact

2.1

2A

REF [141TA3087](#)

2.1

2A

REF [141TA3173](#)

2.1

2A

REF [141TA3100](#)

2.1

2A

REF [141TA2770](#)

2.1

2A

REF [141TA3104](#)

2.1

2A

REF [141TA3131](#)

If key number is not mentioned, there is no reference on the key or the key switch is supplied with different key numbers.

KEY SWITCHES

For all our latest catalogue updates and company info: www.tvh.com



KEY SWITCHES USED FOR TOYOTA

Number of connections	Number of positions	Dia (mm)	Total length (mm)	Type connection	Anti-restart	Key number	TVH-ref of key	REF switch with key	
QTY-CO	QTY-POS	D1	L1	TY-CO	AN-RE	KEY-NR	TVH-KEY		
2	2	22	51	F	no			141TA2894	
2	2	22	53	B	no			141TA3090	
2	3	25	55	E	no			141TA2797	
3	2	19	40	G	no	002	129TA3940	115TA5390	
3	2	19	40	G	no	003	129TA3933	116TA5644	
3	2	19	63	B	no			141TA2615	

REF [141TA2894](#)

2.1

2A

REF [141TA3090](#)

2.1

2A

REF [141TA2797](#)

3.1

3A

REF [115TA5390](#)

2.1

2A

REF [116TA5644](#)

2.1

2A

REF [141TA2615](#)

2.1

2A

If key number is not mentioned, there is no reference on the key or the key switch is supplied with different key numbers.



KEY SWITCHES

For all our latest catalogue updates and company info: www.tvh.com

KEY SWITCHES USED FOR TOYOTA

Number of connections	Number of positions	Dia (mm)	Total length (mm)	Type connection	Anti-restart	Key number	TVH-ref of key	REF switch with key	
QTY-CO	QTY-POS	D1	L1	TY-CO	AN-RE	KEY-NR	TVH-KEY		
3	2	22	47	B	no	702	106TA2629	128TA5985	
3	3	18	78	B	yes	748	141TA2661	110TA7848	
3	3	18	80	B	yes			141TA2880	
3	3	20	63	B	no			141TA3016	
3	3	20	75	E	no			141TA2560	
3	3	20	81	E	no			141TA2793	

REF [128TA5985](#)

2.1

2A

REF [110TA7848](#)

3.1

3A

REF [141TA2880](#)

3.1

3A

REF [141TA3016](#)

3.1

3A

REF [141TA2560](#)

3.1

3A

REF [141TA2793](#)

3.1

3A

If key number is not mentioned, there is no reference on the key or the key switch is supplied with different key numbers.

KEY SWITCHES

For all our latest catalogue updates and company info: www.tvh.com



KEY SWITCHES USED FOR TOYOTA

Number of connections	Number of positions	Dia (mm)	Total length (mm)	Type connection	Anti-restart	Key number	TVH-ref of key	REF switch with key	
QTY-CO	QTY-POS	D1	L1	TY-CO	AN-RE	KEY-NR	TVH-KEY		
3	3	22	52	B	yes			141TA2709	
3	3	25	53	E	no			116TA5606	
3	3	25	56	E	no			141TA2981	
3	3	25	68	E	no			110TA8276	
4	2	22	53	B	no	E30	108TA4994	128TA5979	
4	2	22	56	B	no			141TA2902	

3.1

3A

REF [141TA2709](#)

3.1

3A

REF [116TA5606](#)

3.1

3A

REF [141TA2981](#)

3.1

3A

REF [110TA8276](#)

2.1

2A

REF [128TA5979](#)

2.1

2A

REF [141TA2902](#)

If key number is not mentioned, there is no reference on the key or the key switch is supplied with different key numbers.



KEY SWITCHES

For all our latest catalogue updates and company info: www.tvh.com

KEY SWITCHES USED FOR TOYOTA

Number of connections	Number of positions	Dia (mm)	Total length (mm)	Type connection	Anti-restart	Key number	TVH-ref of key	REF switch with key	
QTY-CO	QTY-POS	D1	L1	TY-CO	AN-RE	KEY-NR	TVH-KEY		
4	3	16	60	E	no			141TA2911	
4	3	19	45	G	no			141TA2756	
4	3	20	63	B	no			141TA3113	
4	4	18	64	B	no			141TA2934	
4	4	18	74	B	no			110TA7817	
4	4	18	76	B	yes			141TA3143	



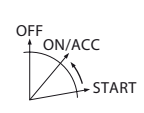

3.1

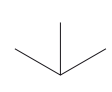

3G

REF [141TA2911](#)



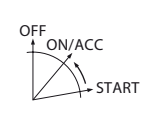

3.1

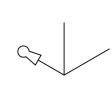

3A

REF [141TA2756](#)



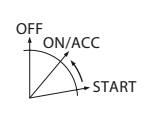

3.1

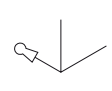

3A

REF [141TA3113](#)



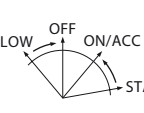

4.2

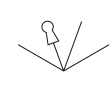

4B

REF [141TA2934](#)



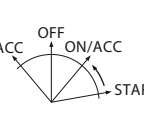

4.1

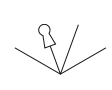

4B

REF [110TA7817](#)



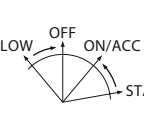

4.2

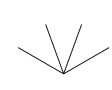

4I

REF [141TA3143](#)

If key number is not mentioned, there is no reference on the key or the key switch is supplied with different key numbers.

KEY SWITCHES

For all our latest catalogue updates and company info: www.tvh.com



KEY SWITCHES USED FOR TOYOTA

Number of connections	Number of positions	Dia (mm)	Total length (mm)	Type connection	Anti-restart	Key number	TVH-ref of key	REF switch with key	
QTY-CO	QTY-POS	D1	L1	TY-CO	AN-RE	KEY-NR	TVH-KEY		
4	4	18	78	E	no	U3317	141TA2682	141TA2444	
4	4	18	81	B	no			141TA2869	
4	4	18	81	B	yes	A62597	128TA5765	141TA2897	
4	4	19	70	H	yes			141TA3074	
4	4	19	79	H	no			141TA2812	
4	4	25	62	E	yes		110TA3256	141TA2780	

4.1

4B

REF [141TA2444](#)

4.2

4B

REF [141TA2869](#)

4.2

4B

REF [141TA2897](#)

4.1

4I

REF [141TA3074](#)

4.1

4B

REF [141TA2812](#)

4.1

4B

REF [141TA2780](#)

If key number is not mentioned, there is no reference on the key or the key switch is supplied with different key numbers.



KEY SWITCHES

For all our latest catalogue updates and company info: www.tvh.com

KEY SWITCHES USED FOR TOYOTA

Number of connections	Number of positions	Dia (mm)	Total length (mm)	Type connection	Anti-restart	Key number	TVH-ref of key	REF switch with key	
QTY-CO	QTY-POS	D1	L1	TY-CO	AN-RE	KEY-NR	TVH-KEY		
4	4	25	64	E	no			141TA2447	
4	4	25	68	E	no			108TA4889	
5	2	22	56	B	no			128TA5969	
5	2	22	56	B	no	E41	108TA4995	108TA8942	
5	2	22	56	B	no	E30	108TA4994	108TA8943	
5	2	22	56	B	no	K03	108TA4996	108TA8941	

4.1

4B

REF [141TA2447](#)

4.1

4B

REF [108TA4889](#)

2.1

2A

REF [128TA5969](#)

2.1

2A

REF [108TA8942](#)

2.1

2A

REF [108TA8943](#)

2.1

2A

REF [108TA8941](#)

If key number is not mentioned, there is no reference on the key or the key switch is supplied with different key numbers.

KEY SWITCHES

For all our latest catalogue updates and company info: www.tvh.com



KEY SWITCHES USED FOR TOYOTA

Number of connections	Number of positions	Dia (mm)	Total length (mm)	Type connection	Anti-restart	Key number	TVH-ref of key	REF switch with key	
QTY-CO	QTY-POS	D1	L1	TY-CO	AN-RE	KEY-NR	TVH-KEY		
5	4	22	59	E	yes	E30	108TA4994	108TA4727	
5	4	25	64	E	yes		141TA2833		
6	3	22	65	B	no	E80	108TA5005	141TA2759	
6	3	25	55	D	yes	HYSTER	129TA3559	141TA2720	
6	4	19	96	E	no		141TA2854		
6	4	20	74	E	no	001	108TA4990	141TA2951	

4.5

4B

REF [108TA4727](#)

4.1

4B

REF [141TA2833](#)

3.1

3A

REF [141TA2759](#)

3.1

3A

REF [141TA2720](#)

4.2

4B

REF [141TA2854](#)

4.2

4B

REF [141TA2951](#)

If key number is not mentioned, there is no reference on the key or the key switch is supplied with different key numbers.



KEY SWITCHES

For all our latest catalogue updates and company info: www.tvh.com

KEY SWITCHES USED FOR TOYOTA

Number of connections	Number of positions	Dia (mm)	Total length (mm)	Type connection	Anti-restart	Key number	TVH-ref of key	REF switch with key	
QTY-CO	QTY-POS	D1	L1	TY-CO	AN-RE	KEY-NR	TVH-KEY		
6	4	20	74	E	no	001	108TA4990	141TA2971	
6	4	20	74	E	no	001	108TA4990	141TA2993	
6	4	20	96	E	no	302	129TA4032	108TA4884	
6	4	25	76	E	no			108TA4643	
6	4	25	92	E	no	A4123	129TA4245	110TA8187	
6	6	22	104	BH	no	1500	108TA5020	141TA2805	

4.2

4B

REF [141TA2971](#)

4.2

4B

REF [141TA2993](#)

4.2

4B

REF [108TA4884](#)

4.2

4B

REF [108TA4643](#)

4.2

4B

REF [110TA8187](#)

6.1

6B

REF [141TA2805](#)

If key number is not mentioned, there is no reference on the key or the key switch is supplied with different key numbers.

KEY SWITCHES

For all our latest catalogue updates and company info: www.tvh.com



KEY SWITCHES USED FOR TOYOTA

Number of connections	Number of positions	Dia (mm)	Total length (mm)	Type connection	Anti-restart	Key number	TVH-ref of key	REF switch with key	
QTY-CO	QTY-POS	D1	L1	TY-CO	AN-RE	KEY-NR	TVH-KEY		
7	3	25	62	B	yes		129TA3664	141TA2926	
7	3	25	62	B	yes		141TA2663	141TA2722	
7	3	25	67	B	yes			141TA3025	
10	3	22	90	BC	no			141TA2837	

OFF
ON/ACC
START

3.1

3A

REF [141TA2926](#)

OFF
ON/ACC
START

3.1

3A

REF [141TA2722](#)

OFF
ON/ACC
START

3.1

3G

REF [141TA3025](#)

OFF
ON/ACC
START

3.1

3A

REF [141TA2837](#)

If key number is not mentioned, there is no reference on the key or the key switch is supplied with different key numbers.



KEY SWITCHES

For all our latest catalogue updates and company info: www.tvh.com

KEY SWITCHES USED FOR WAGNER

Number of connections	Number of positions	Dia (mm)	Total length (mm)	Type connection	Anti-restart	Key number	TVH-ref of key	REF switch with key	
QTY-CO	QTY-POS	D1	L1	TY-CO	AN-RE	KEY-NR	TVH-KEY		
3	2	22	47	B	no	702	106TA2629	141TA3067	
3	2	22	48	B	no	530	106TA2637	141TA2728	
3	2	22	48	B	no	501	106TA2631	115TA5371	
3	2	22	49	B	no	503	106TA2635	141TA2696	
3	2	22	49	B	no	802	108TA5030	141TA3020	
5	2	22	56	B	no		108TA4665	108TA4665	

REF [141TA3067](#)

2.1

2A

REF [141TA2728](#)

2.1

2A

REF [115TA5371](#)

2.1

2A

REF [141TA2696](#)

2.1

2A

REF [141TA3020](#)

2.1

2A

REF [108TA4665](#)

2.1

2A

If key number is not mentioned, there is no reference on the key or the key switch is supplied with different key numbers.

KEY SWITCHES

For all our latest catalogue updates and company info: www.tvh.com



KEY SWITCHES USED FOR WAGNER

Number of connections	Number of positions	Dia (mm)	Total length (mm)	Type connection	Anti-restart	Key number	TVH-ref of key	REF switch with key	
QTY-CO	QTY-POS	D1	L1	TY-CO	AN-RE	KEY-NR	TVH-KEY		
5	2	22	56	B	no	E30	108TA4994	110TA7938	
5	2	22	56	B	no	K03	108TA4996	108TA4692	

REF [110TA7938](#)

2.1

2A

REF [108TA4692](#)

2.1

2A

If key number is not mentioned, there is no reference on the key or the key switch is supplied with different key numbers.



KEY SWITCHES

For all our latest catalogue updates and company info: www.tvh.com

KEY SWITCHES USED FOR YALE

Number of connections	Number of positions	Dia (mm)	Total length (mm)	Type connection	Anti-restart	Key number	TVH-ref of key	REF switch with key	
QTY-CO	QTY-POS	D1	L1	TY-CO	AN-RE	KEY-NR	TVH-KEY		
1	3	0	102	S	no		141TA2670	141TA2539	
2	2	15	53	H	no	601	141TA2656	108TA4605	
2	2	15	53	H	no	684	108TA4988	110TA7729	
2	2	16	63	E	no	83357	129TA4185	141TA3088	
2	2	18	52	G	no	8151	128TA5674	110TA8232	
2	2	18	74	H	no		110TA3083	110TA3083	

3.1

3A

REF [141TA2539](#)

2.1

2A

REF [108TA4605](#)

2.1

2A

REF [110TA7729](#)

2.1

2A

REF [141TA3088](#)

2.1

2A

REF [110TA8232](#)

2.1

2A

REF [110TA3083](#)

If key number is not mentioned, there is no reference on the key or the key switch is supplied with different key numbers.

KEY SWITCHES

For all our latest catalogue updates and company info: www.tvh.com



KEY SWITCHES USED FOR YALE

Number of connections	Number of positions	Dia (mm)	Total length (mm)	Type connection	Anti-restart	Key number	TVH-ref of key	REF switch with key	
QTY-CO	QTY-POS	D1	L1	TY-CO	AN-RE	KEY-NR	TVH-KEY		
2	2	19	43	B	no	2007	128TA5726	141TA3080	
2	2	19	51	G	no			141TA3148	
2	2	19	58	B	no	PK556	108TA5003	141TA2494	
2	2	19	62	B	no	CH512	118TA5814	141TA3101	
2	2	20	59	E	no	CH501	122TA8962	141TA3105	
2	2	20	69	E	no	PK556	108TA5003	141TA3057	

REF [141TA3080](#)

2.1

2A

REF [141TA3148](#)

2.1

2A

REF [141TA2494](#)

2.1

2A

REF [141TA3101](#)

2.1

2A

REF [141TA3105](#)

2.1

2A

REF [141TA3057](#)

2.1

2A

If key number is not mentioned, there is no reference on the key or the key switch is supplied with different key numbers.



KEY SWITCHES

For all our latest catalogue updates and company info: www.tvh.com

KEY SWITCHES USED FOR YALE

Number of connections	Number of positions	Dia (mm)	Total length (mm)	Type connection	Anti-restart	Key number	TVH-ref of key	REF switch with key	
QTY-CO	QTY-POS	D1	L1	TY-CO	AN-RE	KEY-NR	TVH-KEY		
2	2	20	71	E	no	NG100	129TA4188	141TA3132	
2	2	22	62	E	no	455	108TA4991	128TA5611	
2	2	22	67	E	no	KN101	110TA3541	110TA3059	
2	2	22	72	E	no	455	108TA4991	141TA3159	
2	3	25	55	E	no			141TA2798	
3	2	20	54	B	no			141TA2750	

REF [141TA3132](#)

2.1

2A

REF [128TA5611](#)

2.1

2A

REF [110TA3059](#)

2.1

2A

REF [141TA3159](#)

2.1

2A

REF [141TA2798](#)

3.1

3A

REF [141TA2750](#)

2.1

2A

If key number is not mentioned, there is no reference on the key or the key switch is supplied with different key numbers.

KEY SWITCHES

For all our latest catalogue updates and company info: www.tvh.com



KEY SWITCHES USED FOR YALE

Number of connections	Number of positions	Dia (mm)	Total length (mm)	Type connection	Anti-restart	Key number	TVH-ref of key	REF switch with key	
QTY-CO	QTY-POS	D1	L1	TY-CO	AN-RE	KEY-NR	TVH-KEY		
3	2	22	44	B	no			110TA7850	
3	2	22	47	B	no	702	106TA2629	141TA3059	
3	2	22	49	B	no	503	106TA2635	108TA4628	
3	2	22	49	B	no			141TA3040	
3	2	22	53	B	no	701	108TA4993	123TA5743	
3	3	16	59	B	no	83357	129TA4185	128TA5635	

REF [110TA7850](#)

2.1

2A

REF [141TA3059](#)

2.1

2A

REF [108TA4628](#)

2.1

2A

REF [141TA3040](#)

2.1

2A

REF [123TA5743](#)

2.1

2A

REF [128TA5635](#)

3.1

3A

If key number is not mentioned, there is no reference on the key or the key switch is supplied with different key numbers.



KEY SWITCHES

For all our latest catalogue updates and company info: www.tvh.com

KEY SWITCHES USED FOR YALE

Number of connections	Number of positions	Dia (mm)	Total length (mm)	Type connection	Anti-restart	Key number	TVH-ref of key	REF switch with key	
QTY-CO	QTY-POS	D1	L1	TY-CO	AN-RE	KEY-NR	TVH-KEY		
3	3	16	61	E	no	83353	108TA4989	110TA3087	
3	3	16	80	B	no			141TA2907	
3	3	18	78	B	yes	748	141TA2661	128TA5559	
3	3	20	63	B	no			141TA3017	
3	3	20	81	E	no			141TA2794	
3	3	22	52	B	yes			110TA3029	

3.1

3A

REF [110TA3087](#)

3.1

3G

REF [141TA2907](#)

3.1

3A

REF [128TA5559](#)

3.1

3A

REF [141TA3017](#)

3.1

3A

REF [141TA2794](#)

3.1

3A

REF [110TA3029](#)

If key number is not mentioned, there is no reference on the key or the key switch is supplied with different key numbers.

KEY SWITCHES

For all our latest catalogue updates and company info: www.tvh.com



KEY SWITCHES USED FOR YALE

Number of connections	Number of positions	Dia (mm)	Total length (mm)	Type connection	Anti-restart	Key number	TVH-ref of key	REF switch with key	
QTY-CO	QTY-POS	D1	L1	TY-CO	AN-RE	KEY-NR	TVH-KEY		
3	3	22	52	B	yes	E30 BOSCH	141TA2659	141TA2761	
3	3	22	52	B	yes	K11	108TA5017	141TA2713	
3	3	25	47	F	yes		110TA3255	141TA2866	
3	3	25	56	E	no			128TA5606	
4	3	16	60	E	no			141TA2912	
4	3	19	45	G	no			108TA4985	

3.1

3A

REF [141TA2761](#)

3.1

3A

REF [141TA2713](#)

3.1

3A

REF [141TA2866](#)

3.1

3A

REF [128TA5606](#)

3.1

3G

REF [141TA2912](#)

3.1

3A

REF [108TA4985](#)

If key number is not mentioned, there is no reference on the key or the key switch is supplied with different key numbers.



KEY SWITCHES

For all our latest catalogue updates and company info: www.tvh.com

KEY SWITCHES USED FOR YALE

Number of connections	Number of positions	Dia (mm)	Total length (mm)	Type connection	Anti-restart	Key number	TVH-ref of key	REF switch with key	
QTY-CO	QTY-POS	D1	L1	TY-CO	AN-RE	KEY-NR	TVH-KEY		
4	3	20	63	B	no			141TA3114	
4	4	18	64	B	no			141TA2935	
4	4	18	74	B	no			110TA3048	
4	4	18	76	B	yes			141TA3144	
4	4	18	81	B	yes	A62597	128TA5765	141TA2898	
4	4	19	62	BC	no	LUCAS	141TA2658	141TA2596	

3.1

3A

REF [141TA3114](#)

4.2

4B

REF [141TA2935](#)

4.1

4B

REF [110TA3048](#)

4.2

4I

REF [141TA3144](#)

4.2

4B

REF [141TA2898](#)

4.8

4C

REF [141TA2596](#)

If key number is not mentioned, there is no reference on the key or the key switch is supplied with different key numbers.

KEY SWITCHES

For all our latest catalogue updates and company info: www.tvh.com



KEY SWITCHES USED FOR YALE

Number of connections	Number of positions	Dia (mm)	Total length (mm)	Type connection	Anti-restart	Key number	TVH-ref of key	REF switch with key	
QTY-CO	QTY-POS	D1	L1	TY-CO	AN-RE	KEY-NR	TVH-KEY		
4	4	19	63	E	no			141TA2746	
4	4	19	70	H	yes			141TA3075	
4	4	19	79	H	no			141TA2813	
4	4	25	62	E	yes			110TA3256 141TA2781	
5	2	22	56	B	no	E30		108TA4994 141TA2768	
5	2	22	56	B	no	K03		108TA4996 141TA2891	

4.2

4H

REF [141TA2746](#)

4.1

4I

REF [141TA3075](#)

4.1

4B

REF [141TA2813](#)

4.1

4B

REF [141TA2781](#)

2.1

2A

REF [141TA2768](#)

2.1

2A

REF [141TA2891](#)

If key number is not mentioned, there is no reference on the key or the key switch is supplied with different key numbers.



KEY SWITCHES

For all our latest catalogue updates and company info: www.tvh.com

KEY SWITCHES USED FOR YALE

Number of connections	Number of positions	Dia (mm)	Total length (mm)	Type connection	Anti-restart	Key number	TVH-ref of key	REF switch with key	
QTY-CO	QTY-POS	D1	L1	TY-CO	AN-RE	KEY-NR	TVH-KEY		
5	3	18	66	B	yes	14644	108TA5013	141TA3028	
5	3	22	65	B	yes	M516	129TA4256	128TA5842	
5	3	25	62	E	yes			108TA4973	
5	3	25	81	E	yes			128TA5739	
5	4	22	59	E	yes	E30	108TA4994	110TA3055	
5	4	22	65	E	yes	E30	108TA4994	108TA4617	

OFF
ON/ACC
START

3.1

3A

REF [141TA3028](#)

OFF
ON/ACC
START

3.1

3A

REF [128TA5842](#)

OFF
ON/ACC
START

3.1

3A

REF [108TA4973](#)

OFF
ON/ACC
START

3.1

3G

REF [128TA5739](#)

OFF
ON/ACC
START
PUSH AND TURN

4.5

4B

REF [110TA3055](#)

OFF
ON/ACC
GLOW
START
PUSH AND TURN

4.3

4A

REF [108TA4617](#)

If key number is not mentioned, there is no reference on the key or the key switch is supplied with different key numbers.

KEY SWITCHES

For all our latest catalogue updates and company info: www.tvh.com



KEY SWITCHES USED FOR YALE

Number of connections	Number of positions	Dia (mm)	Total length (mm)	Type connection	Anti-restart	Key number	TVH-ref of key	REF switch with key	
QTY-CO	QTY-POS	D1	L1	TY-CO	AN-RE	KEY-NR	TVH-KEY		
5	4	25	64	E	yes			110TA7465	
5	4	28	69	E	no			141TA3023	
6	2	22	77	E	no	KN101	110TA3541	141TA2740	
6	3	22	65	B	no	E80	108TA5005	110TA3037	
6	3	25	55	D	yes	HYSTER	129TA3559	128TA5533	
6	4	16	65	BC	no	LUCAS	141TA2658	108TA4735	

4.1

4B

REF [110TA7465](#)

4.2

4B

REF [141TA3023](#)

2.1

2A

REF [141TA2740](#)

3.1

3A

REF [110TA3037](#)

3.1

3A

REF [128TA5533](#)

4.4

4A

REF [108TA4735](#)

If key number is not mentioned, there is no reference on the key or the key switch is supplied with different key numbers.



KEY SWITCHES

For all our latest catalogue updates and company info: www.tvh.com

KEY SWITCHES USED FOR YALE

Number of connections	Number of positions	Dia (mm)	Total length (mm)	Type connection	Anti-restart	Key number	TVH-ref of key	REF switch with key	
QTY-CO	QTY-POS	D1	L1	TY-CO	AN-RE	KEY-NR	TVH-KEY		
6	4	19	96	E	no			141TA2855	
6	4	20	74	E	no	001	108TA4990	128TA5547	
6	4	20	74	E	no	001	108TA4990	141TA2972	
6	4	20	74	E	no	001	108TA4990	141TA2998	
6	4	20	86	E	no	777EXPORT	115TA5483	128TA5694	
6	4	22	59	B	yes	K30	108TA5014	141TA2705	

REF [141TA2855](#)

4.2

4B

REF [128TA5547](#)

4.2

4B

REF [141TA2972](#)

4.2

4B

REF [141TA2998](#)

4.2

4B

REF [128TA5694](#)

4.2

4B

REF [141TA2705](#)

4.5

4B

If key number is not mentioned, there is no reference on the key or the key switch is supplied with different key numbers.

KEY SWITCHES

For all our latest catalogue updates and company info: www.tvh.com



KEY SWITCHES USED FOR YALE

Number of connections	Number of positions	Dia (mm)	Total length (mm)	Type connection	Anti-restart	Key number	TVH-ref of key	REF switch with key	
QTY-CO	QTY-POS	D1	L1	TY-CO	AN-RE	KEY-NR	TVH-KEY		
6	4	25	76	E	no			141TA2941	
6	4	25	78	E	no			141TA3155	
6	4	28	95	E	no	5154	129TA4124	108TA4965	
6	5	32	83	B	no			141TA2839	
6	6	22	104	BH	no	1500		108TA5020 110TA7972	
7	3	25	54	BD	yes	HYSTER		129TA3559 110TA3034	

4.2

4B

REF [141TA2941](#)

4.2

4B

REF [141TA3155](#)

4.2

4B

REF [108TA4965](#)

5.2

5B

REF [141TA2839](#)

6.1

6B

REF [110TA7972](#)

3.1

3A

REF [110TA3034](#)

If key number is not mentioned, there is no reference on the key or the key switch is supplied with different key numbers.



KEY SWITCHES

For all our latest catalogue updates and company info: www.tvh.com

KEY SWITCHES USED FOR YALE

Number of connections	Number of positions	Dia (mm)	Total length (mm)	Type connection	Anti-restart	Key number	TVH-ref of key	REF switch with key	
QTY-CO	QTY-POS	D1	L1	TY-CO	AN-RE	KEY-NR	TVH-KEY		
7	3	25	62	B	yes		129TA3664	110TA3021	
7	3	25	62	B	yes		141TA2663	110TA7523	
7	3	25	67	B	yes			141TA3026	
7	4	22	57	B	no	14109108	108TA5008	128TA5970	
7	4	26	78	BC	no	14603	141TA2654	110TA3039	
8	3	24	41	D	no			141TA2748	

3.1

3A

REF [110TA3021](#)

3.1

3A

REF [110TA7523](#)

3.1

3G

REF [141TA3026](#)

4.2

4H

REF [128TA5970](#)

4.1

4E

REF [110TA3039](#)

3.3

3A

REF [141TA2748](#)

If key number is not mentioned, there is no reference on the key or the key switch is supplied with different key numbers.

KEY SWITCHES

For all our latest catalogue updates and company info: www.tvh.com



KEY SWITCHES USED FOR YALE

Number of connections	Number of positions	Dia (mm)	Total length (mm)	Type connection	Anti-restart	Key number	TVH-ref of key	REF switch with key	
QTY-CO	QTY-POS	D1	L1	TY-CO	AN-RE	KEY-NR	TVH-KEY		
10	5	22	65	B	yes	K80	108TA5029	141TA2718	
10	5	26	78	BC	no	14603	141TA2654	110TA3024	

5.3

5F

REF [141TA2718](#)

5.1

5F

REF [110TA3024](#)

If key number is not mentioned, there is no reference on the key or the key switch is supplied with different key numbers.



KEY SWITCHES

For all our latest catalogue updates and company info: www.tvh.com

IGNITION SWITCHES WITH LEVER

Number of connections	Number of positions	Dia (mm)	Total length (mm)	Type connection	Anti-restart	Key number	TVH-ref of key	REF switch with key	
QTY-CO	QTY-POS	D1	L1	TY-CO	AN-RE	KEY-NR	TVH-KEY		
2	2	16	63	E	no	83357	129TA4185	108TA4813	
2	2	21	75	E	no			126TA4748	
3	3	13	51	E	no			141TA2913	
3	3	16	59	B	no	83357	129TA4185	141TA2822	
3	3	16	59	B	no	53357	129TA4185	141TA2823	
3	3	16	61	E	no	83353	108TA4989	141TA2460	

With NO-contact

2.1

2A

REF [108TA4813](#)

2.1

2A

REF [126TA4748](#)

3.6

3G

REF [141TA2913](#)

3.1

3A

REF [141TA2822](#)

3.1

3A

REF [141TA2823](#)

3.1

3A

REF [141TA2460](#)

If key number is not mentioned, there is no reference on the key or the key switch is supplied with different key numbers.

KEY SWITCHES

For all our latest catalogue updates and company info: www.tvh.com



IGNITION SWITCHES WITH LEVER

Number of connections	Number of positions	Dia (mm)	Total length (mm)	Type connection	Anti-restart	Key number	TVH-ref of key	REF switch with key	
QTY-CO	QTY-POS	D1	L1	TY-CO	AN-RE	KEY-NR	TVH-KEY		
3	3	16	65	E	no	83357	129TA4185	141TA2844	
3	3	16	76	E	no			110TA8527	
3	3	16	80	B	no			141TA2908	
3	3	19	62	E	no			141TA2635	
3	3	26	59	E	yes			106TA2621	
4	3	16	60	E	no			128TA5998	

3.1

3A

REF [141TA2844](#)

3.6

3G

REF [110TA8527](#)

3.1

3G

REF [141TA2908](#)

3.5

3B

REF [141TA2635](#)

3.1

3G

REF [106TA2621](#)

3.1

3G

REF [128TA5998](#)

If key number is not mentioned, there is no reference on the key or the key switch is supplied with different key numbers.



KEY SWITCHES

For all our latest catalogue updates and company info: www.tvh.com

IGNITION SWITCHES WITH LEVER

Number of connections	Number of positions	Dia (mm)	Total length (mm)	Type connection	Anti-restart	Key number	TVH-ref of key	REF switch with key	
QTY-CO	QTY-POS	D1	L1	TY-CO	AN-RE	KEY-NR	TVH-KEY		
4	3	22	72	F	no		129TA4104	141TA2636	
4	3	25	59	E	yes			128TA5755	
4	4	19	79	H	no			110TA8093	
4	4	26	58	E	no	83357	129TA4184	141TA3151	
5	3	25	81	E	yes			141TA3171	
5	4	25	50	E	no	83357	129TA4185	141TA2637	

3.1

3A

REF [141TA2636](#)

3.1

3A

REF [128TA5755](#)

4.1

4B

REF [110TA8093](#)

4.1

4B

REF [141TA3151](#)

3.1

3G

REF [141TA3171](#)

4.2

4B

REF [141TA2637](#)

If key number is not mentioned, there is no reference on the key or the key switch is supplied with different key numbers.

KEY SWITCHES

For all our latest catalogue updates and company info: www.tvh.com



IGNITION SWITCHES WITH LEVER

Number of connections	Number of positions	Dia (mm)	Total length (mm)	Type connection	Anti-restart	Key number	TVH-ref of key	REF switch with key	
QTY-CO	QTY-POS	D1	L1	TY-CO	AN-RE	KEY-NR	TVH-KEY		
5	4	25	64	E	yes			141TA2774	
6	3	19	55	E	no	CH650	110TA3437	141TA2845	
6	3	19	56	E	no	CH650	110TA3437	141TA2771	
6	3	22	72	F	no			141TA2638	

4.1

4B

REF [141TA2774](#)

3.1

3B

REF [141TA2845](#)

3.1

3D

REF [141TA2771](#)

3.1

3A

REF [141TA2638](#)

If key number is not mentioned, there is no reference on the key or the key switch is supplied with different key numbers.



KEYS

For all our latest catalogue updates and company info: www.tvh.com

COMPLETE RANGE OF KEYS

Key number	Used for	Key sold per	Key REF
SL-NR		AT-SL	SL-RF
001	Allis Chalmers, Boss, BT, Caterpillar, Halla, Hyster, Komatsu, Lancerboss, Linde, Mitsubishi, OM, Steinbock, Toyota, Yale	1	141TA3267
001	Allis Chalmers, Boss, BT, Caterpillar, Halla, Hyster, Komatsu, Lancerboss, Linde, Mitsubishi, OM, Steinbock, Toyota, Yale	2	108TA4990
01		2	141TA3268
002	BT, Manitou, Toyota	1	115TA5399
003	BT, Toyota	1	115TA5470
037		1	141TA3269
038		1	129TA4368
044	Fenwick	1	141TA3270
56	Jungheinrich, Fenwick	2	141TA3271
100	Allis Chalmers, Hyster, Komatsu, Linde, OM, Yale	2	108TA5022
103		2	139TA6753
201		1	141TA3272
202		1	129TA4059
211	TCM	2	110TA3477
255	Hyster, Yale	2	141TA3273
285	Lafis, Lansing, Linde, Manitou	1	110TA3532
301	Lafis, Nissan	1	108TA5004
301	BT, Caterpillar, Clark, Mitsubishi	2	110TA3442
311		2	141TA2669
335		1	141TA3276
335		2	141TA3275
409		1	141TA3277
442		1	141TA3278
455	JLG	1	141TA3279
455	JLG	2	141TA2675
455	JLG	10	127TA2701
456	Fenwick, Hyster, Jungheinrich, Yale, Still	1	110TA3433
456	Fenwick, Hyster, Jungheinrich, Yale, Still	2	110TA3314
501	BT, Caterpillar, Jungheinrich, Komatsu, Mic, Mitsubishi, Steinbock	1	106TA2631
501	BT, Caterpillar, Jungheinrich, Komatsu, Mic, Mitsubishi, Steinbock	2	115TA5484
502		2	106TA2633
503	Clark, Linde, Saxby, Still, Wagner	1	106TA2635
503	Linde, Still	2	129TA4292
508	Jungheinrich	1	108TA5016
510		1	110TA3538
511	TCM	1	110TA3478
512	TCM	2	110TA3479
513	TCM	2	110TA3480
515	TCM	2	110TA3481
523		2	141TA3282
530	Komatsu, Linde, Still, Wagner	1	106TA2637
590	Jungheinrich, Komatsu, Mic, Yale	1	110TA3498
600	TCM	2	110TA3476
601		1	141TA2656
601		2	141TA3284
606	Caterpillar, Jungheinrich, Mitsubishi	1	141TA2665
606		2	141TA3285
633	BT, Fenwick, Hyster, Lansing, Linde, OM, Still, Wagner, Yale	1	108TA5011
684	Fenwick, Linde, Prat, Saxby, Still	2	108TA4988
695	Fenwick, Komatsu, Lansing, Linde, Mic	1	108TA5010



COMPLETE RANGE OF KEYS

Key number	Used for	Key sold per	Key REF
SL-NR		AT-SL	SL-RF
701	BT, Boss, Jungheinrich, Komatsu, Mic, Steinbock, Yale	1	110TA3533
701	Caterpillar, Jungheinrich, Mic, Mitsubishi	3	116TA5648
702	BT, Caterpillar, Jungheinrich, Komatsu, Mic, Mitsubishi, Steinbock, Toyota	3	108TA4992
713	Climax Coventry, Kalmar, TCM	2	129TA4260
724	Climax Coventry, Kalmar, TCM	2	110TA3482
735	Climax Coventry, Kalmar, TCM	2	110TA3483
738	BT, Jungheinrich, Komatsu, Mic, Steinbock	1	108TA5018
738	BT, Jungheinrich, Komatsu, Mic, Steinbock	3	110TA3353
741	Caterpillar, Jungheinrich, Mitsubishi	3	129TA4135
748		2	141TA2661
777		1	141TA3289
787	Komatsu	1	141TA3290
791		1	141TA3291
794		1	141TA3292
801	Lansing, Linde	1	122TA8960
801	Lansing, Linde	2	108TA5025
802	Fenwick, Lansing, Linde	2	108TA5030
835	Climax Coventry, Kalmar, TCM	1	110TA3301
845	Caterpillar, Jungheinrich, Mitsubishi, Rocla	2	141TA3294
845	Caterpillar, Jungheinrich, Mitsubishi, Rocla	1	141TA3295
846	Climax Coventry, Kalmar, TCM	2	110TA3484
857	Climax Coventry, Kalmar, TCM	2	129TA4236
1001	Clark, JCB, Linde, Still, Wagner	1	118TA5815
1087		1	141TA3296
1099		1	141TA3297
1124		1	110TA3531
1500	Caterpillar, Jungheinrich, Mitsubishi, Yale	1	108TA5020
1539		1	141TA3298
2007	Allis Chalmers, BT, Caterpillar, Clark, Hyster, Komatsu, Yale	2	128TA5726
2395	Caterpillar, Mitsubishi	2	141TA3299
2399		1	141TA3300
2550	Caterpillar, Jungheinrich, Mic, Mitsubishi, Yale	1	110TA3434
2720	TCM	2	110TA3466
2722	TCM	2	110TA3468
2726	TCM	2	110TA3470
2730	TCM	2	110TA3472
2734	TCM	2	110TA3474
2801		2	141TA3301
3000		2	128TA3051
3095	JLG	1	122TA8983
3553	Toyota	1	115TA5480
5154	Caterpillar, Jungheinrich, Mitsubishi, Yale	2	129TA4126
5252		1	141TA3302
5541	Nyk	1	141TA3303
6896	Toyota	1	141TA3305
6896	Toyota	2	140TA6904
7725	Hyster, Still, Yale	1	110TA3438
7730	Hyster, Linde, Still, Yale	1	129TA3858
8151	Lafis	2	129TA4152
8888		1	141TA3308
9211	Caterpillar, Jungheinrich, Mitsubishi	1	115TA5464
9401		1	122TA8945



KEYS

For all our latest catalogue updates and company info: www.tvh.com

COMPLETE RANGE OF KEYS

Key number	Used for	Key sold per	Key REF
SL-NR		AT-SL	SL-RF
9402		1	122TA8955
9403		1	122TA8949
9404		1	122TA8954
9405		1	122TA8953
9406		1	122TA8956
9407		1	122TA8951
9408		1	122TA8952
9409		1	122TA8947
9410		1	122TA8948
9411		1	122TA8981
9412		1	122TA8946
9413		1	122TA8941
9414		1	122TA8977
9415		1	122TA8968
9416		1	116TA5650
9417		1	122TA8975
9418		1	122TA8979
9419		1	122TA8982
9420		1	122TA8978
9421		1	122TA8966
9422		1	122TA8976
9423		1	122TA8980
9424		1	122TA8974
9425		1	122TA8973
9426		1	129TA4064
9427		1	129TA4061
9428		1	129TA4066
9429		1	129TA4062
9430		1	129TA4065
9431		1	141TA3309
9432		1	141TA3310
9433		1	141TA3311
9434		1	141TA3312
9435		1	141TA3313
9436		1	141TA3314
9437		1	141TA3315
9438		1	141TA3316
9439		1	141TA3317
9440		1	141TA3318
9441		1	141TA3319
9442		1	141TA3320
9443		1	141TA3321
9444		1	141TA3322
9445		1	141TA3323
9446		1	141TA3324
9447		1	141TA3325
9448		1	141TA3326
9449		1	141TA3327
9450		1	141TA3328
9451		1	141TA3329
9452		1	141TA3330
9453		1	141TA3331



COMPLETE RANGE OF KEYS

Key number	Used for	Key sold per	Key REF
SL-NR		AT-SL	SL-RF
9454		1	141TA3332
9455		1	141TA3333
9456		1	141TA3334
9457		1	141TA3335
9458		1	141TA3336
9459		1	141TA3337
9460		1	141TA3338
9471		2	141TA2657
9901	JLG	1	141TA3339
9901	JLG	2	115TA5467
14602		1	129TA4296
14603	Allis Chalmers, Clark, Climax Coventry, Crown, Fenwick, Hyster, JLG, Jungheinrich, Kalmar, Komatsu, Lansing, Linde, Manitou, Mitsubishi, Steinbock, Still, Toyota, Yale	1	129TA3351
14603	Allis Chalmers, Clark, Climax Coventry, Crown, Fenwick, Hyster, JLG, Jungheinrich, Kalmar, Komatsu, Lansing, Linde, Manitou, Mitsubishi, Steinbock, Still, Toyota, Yale	2	139TA5092
14607	Boss, BT, JCB, Jungheinrich, Kalmar, Komatsu, Lancerboss, Lansing, Manitou, Mic, Steinbock	1	129TA4286
14607	Boss, BT, JCB, Jungheinrich, Kalmar, Komatsu, Lancerboss, Lansing, Manitou, Mic, Steinbock	2	116TA5649
14609	Boss, BT, Clark, Jungheinrich, Komatsu, Steinbock	1	110TA3458
14609	Boss, BT, Clark, Jungheinrich, Komatsu, Steinbock	2	110TA3491
14609		1	141TA3342
14610	Hyster, Lafis, Linde	1	108TA5033
14644	Atlet, BT, Jungheinrich, Komatsu, Manitou, Mic, Nissan, Steinbock	1	129TA4057
24401	Mitsubishi, Nyk	2	141TA3343
31131	Allis Chalmers, Clark, Hyster, Komatsu, Toyota, Yale	2	108TA5021
37223	Linde, Lansing, Saxby, Still	1	110TA3502
73034		1	129TA4275
73037		1	141TA3346
73038		1	141TA3347
80339		1	141TA3348
83357	Allis Chalmers, Caterpillar, Clark, Hyster, JLG, Kalmar, Mitsubishi, Toyota, Yale	1	129TA4184
83357	Allis Chalmers, Caterpillar, Clark, Hyster, JLG, Kalmar, Mitsubishi, Toyota, Yale	2	108TA4989
92274	Caterpillar, JCB, Lansing, Linde, Sanderson, Still	2	110TA3536
92278	Lansing, Linde	2	110TA3540
92301	Henley, Lansing, Linde	1	141TA3349
93201	Henley, Lansing, Linde	1	108TA5027
123243	Caterpillar, Clark, Hyster, Mitsubishi, Nissan, Nyk, Yale	2	108TA5035
511213	BT, Manitou, Toyota	1	129TA4299
511323	TCM	2	110TA3463
511416	BT, Caterpillar, Hyster, Manitou, Mitsubishi, Toyota, Yale	1	141TA3351
511416	BT, Caterpillar, Hyster, Manitou, Mitsubishi, Toyota, Yale	2	108TA5037
512421	TCM	2	110TA3464
513454	TCM	2	110TA3465
554142		1	141TA3352
1D21	BT, Faba, Jungheinrich, Komatsu, Mic, Steinbock	1	108TA5007
2233X	BT, Jungheinrich, Komatsu, Mic, Steinbock	1	110TA3496
302 TOYOTA	Toyota, Manitou	1	122TA8988
3A1	Caterpillar, Jungheinrich, Mitsubishi	3	141TA3354
3A36	Jungheinrich	1	108TA5019



KEYS

For all our latest catalogue updates and company info: www.tvh.com

COMPLETE RANGE OF KEYS

Key number	Used for	Key sold per	Key REF
SL-NR		AT-SL	SL-RF
421E	JLG	1	129TA4269
421E	JLG	2	139TA5093
4241A		1	129TA4086
458A		2	129TA4114
459A		2	141TA3355
4A251	Boss, BT, Jungheinrich, Komatsu, Lancerboss, Mic, Nissan, Steinbock, Still, Toyota, Wagner	1	110TA3462
50PIECESCLE455		50	141TA3356
701 TCM	Clark, OMG, TCM	2	122TA8971
701BLACK		3	141TA3357
777EXPORT	Clark, Hyster, Samsung, Yale	2	115TA5483
777KOREA	Clark, Samsung	2	122TA8957
8D15	BT, Clark, Hyster, Yale	1	110TA3441
8R1		1	129TA4223
8R15	BT, Clark	2	122TA8963
A01	Clark, Hyster, Yale	1	110TA3443
A01 COBO	BT, Cesab	2	141TA3358
A03	Clark, Hyster, Yale	1	110TA3444
A04	Clark, Hyster, Yale	1	110TA3445
A05	Clark, Hyster, Yale	1	110TA3446
A06	Clark	1	141TA3359
A08	Clark, Hyster, Yale	1	110TA3447
A09	Clark, Hyster, Yale	1	110TA3448
A10	BT, Caterpillar, Jungheinrich, Komatsu, Mitsubishi, Steinbock	1	129TA4323
A10 BORKEY	Jungheinrich, Linde, Still, Yale	1	110TA3486
A10MERIT	Clark, Hyster, Yale	1	110TA3244
A11	Clark, Hyster, Yale	1	110TA3450
A1132	Linde	2	141TA3360
A12	Clark, Hyster, Yale	2	141TA3361
A126	Allis Chalmers, BT, Crown, Komatsu	1	141TA3362
A13	Clark, Hyster, Yale	1	110TA3451
A14	Clark, Hyster, Yale	1	110TA3452
A15	Clark, Hyster, Yale	1	110TA3453
A16	Clark, Hyster, Yale	1	110TA3249
A17	Clark, Hyster, Yale	1	129TA4351
A18	Clark, Hyster, Yale	1	110TA3455
A19	Clark, Hyster, Yale	1	110TA3456
A20	Clark, Hyster, Yale	1	110TA3457
A314	Manitou	1	141TA3363
A34013	Toyota	1	141TA3364
A4123	Manitou, Toyota	1	129TA4243
A5160	Caterpillar, Mitsubishi	2	141TA2666
A62597	BT, Cesab, Clark, Hyster, Manitou, Mitsubishi, Toyota, Yale	1	129TA4109
AA		1	141TA3365
AA2AB		2	110TA3506
AAAA		1	129TA4259
B011		1	141TA3366
B11		1	128TA5705
B721		1	141TA3367
BH-1	Bosch, Wagner	1	141TA3368
BH4	BT	1	141TA3370
BL2		2	141TA3371



COMPLETE RANGE OF KEYS

Key number	Used for	Key sold per	Key REF
SL-NR		AT-SL	SL-RF
BO4		1	141TA3372
BS15L		2	141TA3373
BT4		3	141TA3374
C001		1	141TA3375
C11131	Manitou	1	129TA4250
C250	Clark, Crown, Hyster, Linde, Toyota, Yale	1	110TA3432
C40		1	141TA3376
C415A		2	141TA3377
C41C	Halla	1	141TA3378
C5224	Mitsubishi, Nyk	2	141TA3379
CG16	JLG	1	126TA4754
CH 751	Crown, Hyster, Komatsu, Lansing, Linde, Still, Yale	1	110TA3367
CH501	Clark, JLG	1	122TA8962
CH506	JLG	1	129TA4106
CH512	Caterpillar, Clark, Hyster, Nissan, Yale	1	110TA3503
CH512	Caterpillar, Clark, Hyster, Nissan, Yale	2	118TA5814
CH528	Allis Chalmers, Clark, Crown, Hyster, Komatsu, JLG, Toyota, Yale	2	129TA4366
CH650		2	110TA3437
CH7		2	141TA3380
CH751	JLG	2	141TA3381
CROWN	Crown, Yale	1	110TA3228
CS7		1	141TA3382
D100	Hyundai	1	129TA4204
D24	Jungheinrich	2	141TA3383
D250	Allis Chalmers, Clark, Komatsu, TCM	1	141TA3384
D250	Allis Chalmers, Clark, Komatsu, TCM	2	141TA3385
D3		2	141TA2664
DAT12		1	110TA3509
DAV2313E	Fenwick, Linde	1	110TA3487
E01	Bosch, Wagner	1	110TA3511
E02	Bosch, Wagner	1	110TA3512
E03	Bosch, BT, Hyster, Lansing, Linde, Still, Toyota, Wagner, Yale	1	110TA3459
E04	Bosch, Still, Wagner	1	110TA3513
E06	Bosch, Linde	1	141TA3387
E07	Bosch	1	141TA3388
E08	Bosch	1	110TA3539
E10	Bosch, BT, Still, Toyota, Wagner	1	110TA3514
E11	Bosch, BT, Linde, Still, Toyota	1	108TA5026
E12	Bosch, Linde, Still, Wagner	1	110TA3515
E13	Bosch, Still, Wagner	1	115TA5481
E14	Bosch, BT, Toyota, Wagner	1	110TA3516
E15	Bosch, Still, Wagner	1	110TA3517
E16	Bosch, BT, Still, Toyota, Wagner	1	110TA3518
E19	Bosch, BT, Linde, Toyota, Wagner	1	110TA3519
E21	Bosch, BT, Toyota, Wagner	1	141TA3389
E22	Bosch, Wagner	1	115TA5472
E24	Bosch, Linde, Manitou, Prat, Still, Wagner	1	141TA3390
E25	Bosch, Linde, Wagner	1	110TA3520
E254	Komatsu, Steinbock	1	108TA5012
E254	Komatsu, Steinbock	2	122TA8944
E26	Bosch, Still, Wagner	1	110TA3521
E27	Bosch, Wagner	1	110TA3522



KEYS

For all our latest catalogue updates and company info: www.tvh.com

COMPLETE RANGE OF KEYS

Key number	Used for	Key sold per	Key REF
SL-NR		AT-SL	SL-RF
E28	Bosch, BT, Linde, Toyota, Wagner	1	110TA3523
E29	Bosch, Linde, Wagner	1	110TA3524
E30	Bosch, BT, Caterpillar, Clark, Fenwick, Hyster, Lansing, Linde, Jungheinrich, Manitou, Mic, Mitsubishi, Nissan, Saxby, Sichelshmidt, Steinbock, Still, Toyota, Wagner, Yale	1	108TA4994
E30 COBO	Toyota	2	141TA3391
E31	Bosch, Linde, Still, Wagner	1	110TA3525
E32	Bosch, Wagner	1	129TA4119
E33	Bosch, Linde, Wagner	1	110TA3526
E34	Bosch, Wagner	1	110TA3510
E35	Bosch, Linde, Still, Wagner	1	110TA3527
E36	Bosch, Wagner	1	122TA8986
E37	Bosch, Still, Wagner	1	110TA3528
E38	Bosch, BT, Toyota, Wagner	1	141TA3392
E39	Bosch, BT, Toyota, Wagner	1	141TA3393
E41	Allis Chalmers, Bosch, Toyota, Komatsu, Still, BT, Linde, Wagner	1	108TA4995
E42	Bosch, Toyota, BT, Wagner	1	129TA4045
E43	Bosch, Toyota, Still, BT, Wagner	1	122TA8984
E44	Bosch, Linde, Wagner	1	141TA3394
E45	Bosch, Toyota, Still, BT, Linde, Wagner	1	110TA3529
E47	Bosch, Toyota, Still, BT, Linde, Wagner	1	110TA3530
E48	Bosch, Toyota, BT, Wagner	1	141TA3395
E49	Bosch, Toyota, BT, Wagner	1	141TA3396
E50	Bosch, Toyota, BT, Wagner	1	141TA3397
E77		1	141TA3398
E80	Bosch, BT, Clark, Hyster, Mitsubishi, Steinbock, Toyota, Yale	1	108TA5005
EK333	Caterpillar, Jungheinrich, Komatsu, Mitsubishi, Steinbock	1	122TA8958
EK436		1	141TA3399
F315		1	122TA8985
FA537	Hyster	1	141TA3400
FAR2R		1	141TA3401
FAR8		1	141TA3402
FH184	Manitou	2	141TA3403
FP748	Hyster	1	115TA5469
FS880	Climax Coventry, Lansing, Linde, Saxby, Still	1	108TA5024
FS880	Climax Coventry, Lansing, Linde, Saxby, Still	2	141TA3404
FS881	Lansing, Linde, Still	1	129TA4208
FS882	Lansing, Linde	1	110TA3499
FS883	Lansing, Linde, Still	1	141TA2677
FS884	Lansing, Linde	1	122TA8943
FS885	Lansing, Linde	1	108TA5028
FS888	Boss, BT, Jungheinrich, Komatsu, Lancerboss, Linde, Lucas, Mic, Steinbock	1	108TA5032
FS889	Lansing, Linde	1	141TA3405
FS890	Lansing, Linde	1	141TA3406
FS901	Lansing, Linde	1	141TA3407
FS915	Lansing	1	129TA4274
FS933	Lansing	1	115TA5465
FS936	Lansing, Linde	1	110TA3500
GC020	Clark	2	141TA3408
GILBERT		1	141TA3409
GP018	Hyster, Toyota, Yale	2	141TA3410
H21		1	141TA3411



COMPLETE RANGE OF KEYS

Key number	Used for	Key sold per	Key REF
SL-NR		AT-SL	SL-RF
H33		1	129TA4364
H6167		1	115TA5476
HD62	Caterpillar	1	110TA3535
HD62	Caterpillar	2	141TA3412
HD82		1	110TA3534
HF44	Jungheinrich, Mic, Yale	1	110TA3439
HF75R	Lansing, Linde	2	129TA4117
HU27		1	141TA3413
JLG1		2	141TA3415
K03	Bosch, BT, Manitou, Toyota	1	108TA4996
K10	Bosch	1	141TA3416
K11	Atlet, Bosch, BT, Caterpillar, Jungheinrich, Linde, Mitsubishi, Still	1	108TA5017
K200		2	128TA5759
K240		1	141TA3417
K30	Bosch	1	108TA5014
K720	Climax Coventry, Kalmar, TCM	2	110TA3467
K722	Climax Coventry, Kalmar, TCM	2	110TA3469
K726	Climax Coventry, Kalmar, TCM	2	110TA3471
K730	Climax Coventry, Kalmar, TCM	2	110TA3473
K734	Climax Coventry, Kalmar, TCM	2	110TA3475
K80	Bosch, Clark, Hyster, Jungheinrich, Linde, Still, Yale	1	108TA5029
KL3		2	129TA4129
KN101		1	110TA3541
KUB1		1	141TA3418
KW14		1	141TA2681
LF4	Caterpillar, JCB, Lansing, Linde, Sanderson, Still	1	141TA3419
LL11	Caterpillar, Linde, Still	1	122TA8969
LUCAS	Balkancar, Caterpillar, Fenwick, JCB, Komatsu, Lansing, Linde, Lucas, Manitou, Still, Toyota, Yale	1	110TA3257
M1-545-4		2	129TA4196
M516	Yale	1	
M516	Yale	2	128TA5843
MC01	Caterpillar, Jungheinrich, Linde, Mitsubishi, Mic, Steinbock, Still, Yale	1	129TA3841
MC03		1	129TA4265
MC05	Caterpillar	1	129TA4303
MC1	Caterpillar, Hyster, Jungheinrich, Linde, Mic, Mitsubishi, Steinbock, Still, Yale	1	110TA3366
MC1	Caterpillar, Hyster, Jungheinrich, Linde, Mic, Mitsubishi, Steinbock, Still, Yale	2	110TA3224
MC15		1	129TA4266
MC16		1	141TA3422
MC35	Caterpillar, JCB, Linde, Manitou	1	129TA4213
MC43		1	129TA4369
MC72	Henley, Lansing	1	141TA3424
MC74		1	141TA3425
MC80	Linde	1	141TA3426
MRT1RP		2	141TA3427
MS1	Lafis	1	141TA3428
MS2		1	141TA3429
N1417	Clark, Nissan, OMG	1	110TA3435
NF200		2	141TA3430
NG100	BT, Caterpillar, Hyster, Mitsubishi, Toyota, Yale	2	129TA4188
P107	Caterpillar, Jungheinrich, Komatsu, Mic, Mitsubishi, Still	1	110TA3493
P149	Jungheinrich	1	141TA3433



KEYS

For all our latest catalogue updates and company info: www.tvh.com

COMPLETE RANGE OF KEYS

Key number	Used for	Key sold per	Key REF
SL-NR		AT-SL	SL-RF
P27		1	141TA2676
P41		1	115TA5475
P50	BT, Jungheinrich, Komatsu, Steinbock	1	110TA3436
P56	Bosch, Jungheinrich, Mic, Still	1	110TA3485
PGT15R	Manitou	1	141TA3434
PK510		2	129TA4132
PK556	Caterpillar, Clark, Crown, Hyster, JLG, Jungheinrich, Mitsubishi, Toyota, Yale	1	141TA3435
PK556	Caterpillar, Clark, Crown, Hyster, JLG, Jungheinrich, Mitsubishi, Toyota, Yale	2	108TA5003
R200		2	141TA3436
R85P	Halla	1	141TA3437
RN11		1	129TA4258
RO20	Manitou	1	141TA3438
RO21	Hyster, Yale	1	129TA4319
S25	Bosch	1	115TA5477
S450		2	141TA2672
SG26	BT, Komatsu, Steinbock	1	141TA3439
SIR 189		1	129TA4249
SOUTHCO 14603		1	141TA3440
T251	Jungheinrich, Mic, Steinbock	1	110TA3494
T252	BT, Jungheinrich, Komatsu, Mic, Steinbock	1	141TA3441
T700	Climax Coventry, Mitsubishi, Nyk	2	141TA3442
T800A	Caterpillar, Climax Coventry, Kalmar, Mitsubishi, Nyk	2	108TA5006
TAF1	Hyster, Lansing, Linde, Still, Yale	1	110TA3311
TF1087	Climax Coventry, Kalmar, Lansing, Linde	1	129TA4145
TL1		1	141TA3443
TM211	Linde	1	129TA4093
TOK001	Jungheinrich	1	129TA4199
TOK3	Crown, Hamech	1	122TA8961
TOYO25		1	129TA4218
TYA67	Manitou	1	129TA4298
U3317	Hyster, Nissan, Shinko, Yale	1	129TA4241
U39	Bosch	1	141TA3444
U7800	Allis Chalmers, Komatsu	2	129TA4246
UN13	Manitou	1	110TA3488
UNI1		2	141TA3445
UNI11A	BT, Komatsu, Steinbock	1	141TA3446
WA01	Manitou	1	122TA8950
WA05		1	122TA8959
WA10	Lansing	1	141TA3447
X1000GR	Clark	1	129TA4362
X1062DV	Hyster, Mitsubishi, Nissan, Yale	1	129TA4096
Y11		2	141TA3448
Y17	Yale	1	141TA3449
YA11D		1	141TA3450
YA4		1	141TA3451
YANMAR		2	141TA3452
YM34L		1	141TA3453



SAFE-T-LOCK™ STL 1000

SAFE-T-LOCK™

REF 125TA5079

- 12-120 VDC
- Waterproof IP65
- Up to 99 different users/drivers
The STL requires entry of a two-digit user number and valid 4- to 8-digit access code before the vehicle can be operated. All user codes can be reprogrammed and unused user numbers can be temporarily disabled for additional security.
- 1 programmable supervisor code
Entering the supervisor's menu allows you to change the supervisor's code into your own desired 4- to 8-digit code.
- Last user identification
The STL1000 can identify to the supervisor the user number of the last user of a vehicle.
- Automatic shut-off after 3 minutes (fixed time) of vehicle inactivity
The STL1000 incorporates a feature that detects vehicle activity. If the vehicle has been inactive for more than 3 minutes, the STL1000 will deactivate, securing the vehicle.
- Maintenance alert after 250 hours
This feature can be activated or deactivated by the supervisor.

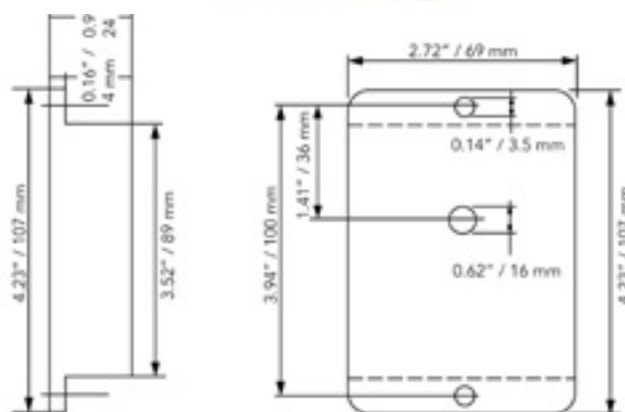

RoHs conform





PROGRAMMABLE CODE SWITCH

For all our latest catalogue updates and company info: www.tvh.com

We offer a complete range of programmable code switches to prevent unauthorized use of your vehicles. All keypads are designed for use on both battery and I.C. engine powered vehicles.

PROGRAMMABLE SECURITY LOCK PSL

Basic Security Lock that allows controlled access to vehicles, so that only those persons with the user code can start and operate the vehicle.

REF 135TA3497

- 12-90 VDC
- **Waterproof IP65**
- **1 adjustable user code.**
With the PSL installed, the vehicle can not be started without entering the 4-digit user code.
- **1 fixed supervisor code.**
For security reasons, the PSL user code can be changed by the supervisor.

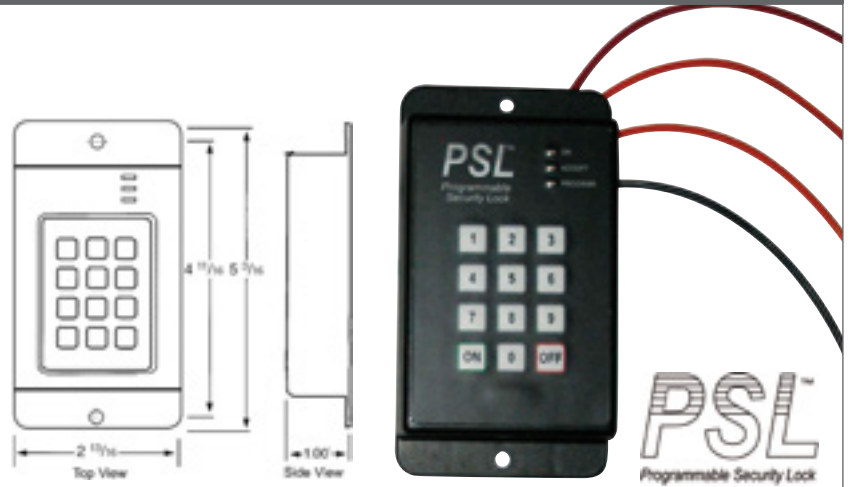

PROGRAMMABLE SECURITY LOCK PSL+

The PSL+™ Programmable Security Lock is an enhanced version of our familiar PSL™ product with several additional features. Like the original, this version is primarily designed for use with both battery and I.C. powered vehicles to prevent unauthorized operation of the vehicle. In addition, however, the PSL+ has expanded the PSL concept by incorporating several useful new functions.

REF 135TA3498

- 12-90 VDC
- **Waterproof IP65**
- **Up to 99 different users/drivers.**
Once installed, the PSL+ requires entry of a 2-digit user number and valid 4-digit access code before the vehicle can be operated. All user codes can be reprogrammed and unused user numbers can be temporarily disabled for additional security.
- **1 programmable supervisor code.**
Even the supervisor's access code can be changed using the factory programmed reset code, linked to the serial number of your PSL+.
- **Last user identification.**
The PSL+ can identify to the supervisor the user number of the last user of a vehicle.
- **Automatic shut-off after a preset period of vehicle inactivity.**
The PSL+ incorporates a feature that detects vehicle activity. If the vehicle has been inactive beyond a specified period of time, the PSL+ will deactivate, securing the vehicle. This feature can be activated or deactivated as desired.
- **Maintenance alert after a preset number of hours.**
The PSL+ can accumulate vehicle usage time and provide audible and visible signals indicating when vehicle maintenance is due. After maintenance is performed, the cycle can be reset as desired. This feature can be activated or deactivated by the supervisor.
- **Accumulated time.**
The PSL+ can accumulate total vehicle usage time. This accumulated time can be accessed through the supervisor code.

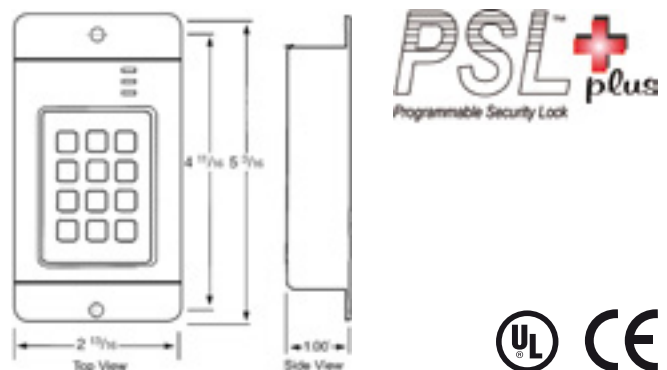



ACCESS CONTROL SYSTEM WITH ELECTRONIC KEYS

Basic version: access control

Item	Description	REF
Control box 12-80 VDC	With key reader and wiring harness	135TA3501
Starter kit	Includes 3 keys: <ul style="list-style-type: none"> • Green: for programming • Orange: immobilization and restart • Red: erasing data 	135TA3502
Driver keys	Blue Black	135TA3503 135TA3504
Power relays	Obligatory to install a power relay. 12 V 24 V 48 V 80 V	135TA3505 135TA3506 135TA3507 135TA3508
Starting button	For use on IC trucks	135TA3509
Shock detector	Connecting the optional shock detector to the access control system, allows you to activate an external horn or to slow down the truck when a preset shock level has been exceeded.	135TA3510
Software kit with PC interface, needed if a shock detector is used.	For easy and fast programming of the shock detector and driver keys. Includes PC key reader and 3 keys.	135TA3511



Technical specifications

- Operating voltage: 12-80 VDC
- Working temperature: -20 °C to +60 °C
- Capacity: 40 users
- Programming: no software/only one initialization key is needed
- Dimensions box: 80 x 47 x 30 mm (LxWxH)

Complete data logging system with optional shock detector

This system has been specially designed for EASY programming. A simplified software package allows you to start up the system in 3 steps:

- Creation of the forklifts
- Creation of the drivers
- Assigning the different drivers to the forklifts

Simplified, but complete system to manage the drivers with date and hour of usage. With the optional shock detector, the system also indicates the G-value of the shocks.

EASY data retrieving with the picking box.

Item	Description	REF
Control box 12-80 VDC	With key reader and wiring harness	135TA3512
Driver keys	Blue Black	135TA3503 135TA3504
Starting button	For use on IC trucks	135TA3509
Software kit	For keys management	135TA3513
Picking box	For easy data retrieving	135TA3514
Shock detector	For shock management	135TA3510



Technical specifications

- Operating voltage: 12-80 VDC
- Working temperature: -20 °C to +60 °C
- Programming: software package
- Capacity: max 10 forklifts/driver
- Output: 2 outputs
- Input: 6 inputs
- Dimensions box: 113 x 76 x 32 mm (LxWxH)



PROGRAMMABLE CODE SWITCH

For all our latest catalogue updates and company info: www.tvh.com

A large area of the page consisting of numerous horizontal dotted lines, intended for writing or drawing.

...not cheap parts but
quality parts cheaper...

TOTALSOURCE[®]



- 500 000 part numbers in stock
- Parts and accessories for all brands
- 24/48 hour delivery
- Worldwide sea-air-road distribution
- More than 100 000 m² of warehousing
- Worldwide quality guarantee

www.tvh.com



FOLLOW US



PARTS & ACCESSORIES



PARTS & ACCESSORIES